

Optical Active 3D Scanning

Gianpaolo Palma

3D Scanning Taxonomy

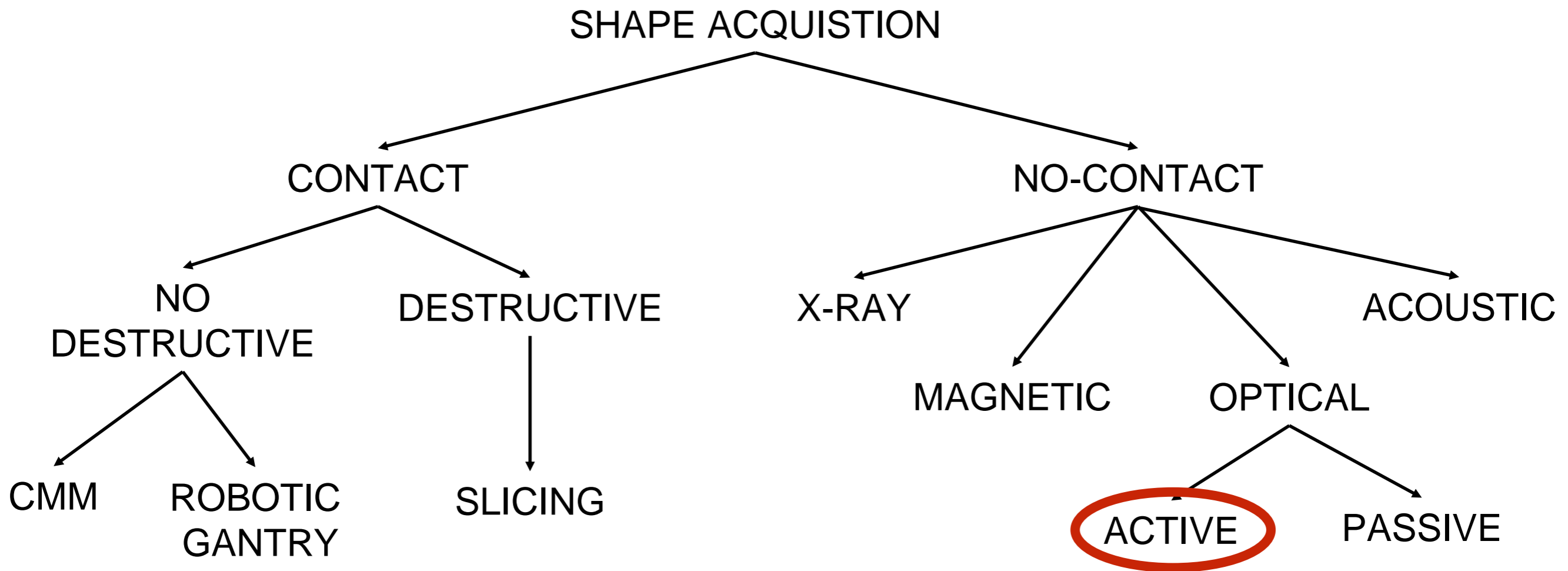

Recap

Computational Tomography and Magnetic Resonance

- **Advantages**
 - A complete model is returned in a single shot, registration and merging not required
 - Output: volume data, much more than just an exterior surface
- **Disadvantages**
 - Limitation in the size of the scanned object
 - Cost of the device
 - Output: no data on surface attributes (e.g. color)

Recap

Multi-View Stereo Reconstruction

- **Advantages**
 - Cheap (no scanning device needed), fast tech evolution
 - Good flexibility (both small and huge model can be acquired)
 - Cameras are more easy to use than a scanner (lighter, no tripod, no power, multiple lenses ...)
 - Non-expert users can create 3D models
- **Disadvantages**
 - Accuracy (not so accurate, problems with regions with insufficient detail)
 - Slower than active techniques (many images to process and merge)
 - Not all the objects can be acquired

Active Optical Technology

- **Advantages**

- Using active lighting is much faster
- Safe - Scanning of soft or fragile objects which would be threatened by probing
- Set of different technologies that scale with the object size and the required accuracy

- **Disadvantages**

- Can only acquire visible portions of the surface
- Sensitivity to surface properties (transparency, shininess, darkness, subsurface scatter)
- Confused by interreflections

Active Optical Technology

- Active optical vs CT scanner
 - Cheaper, faster, scale well with object size
 - But no volume information and more processing
- Active optical vs Multi-view stereo
 - Faster and more accurate
 - But more expensive and more user expertise

Active Optical Technology

- Depth from Focus
 - Confocal microscopy
- Interferometry
- Triangulation
 - Laser triangulation and structured light
- Time-of-Flight
 - Pulse-based and Phase-based

Why different active optical technology?

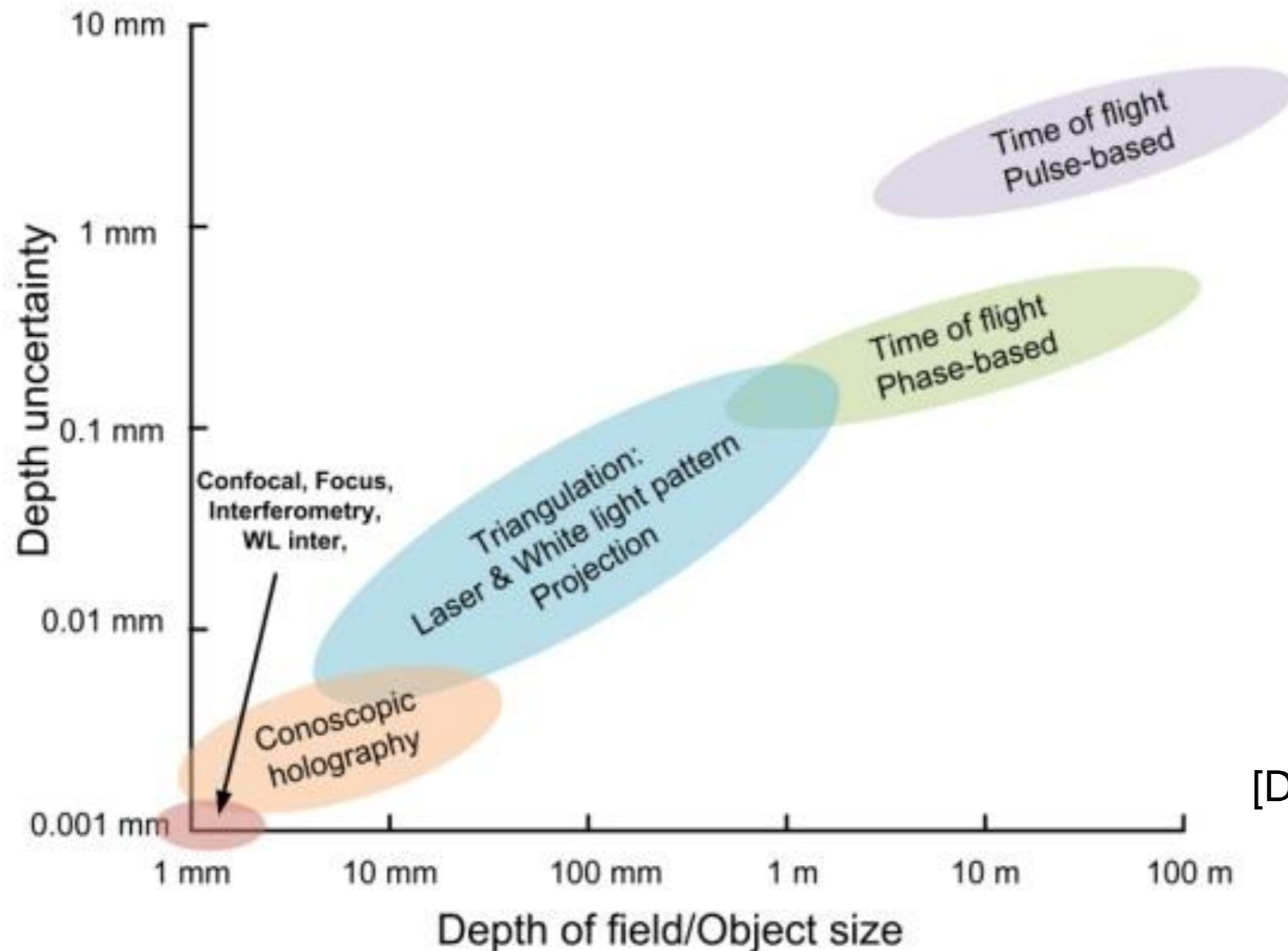

[Drouin et al., 2012]

Confocal Microscopy

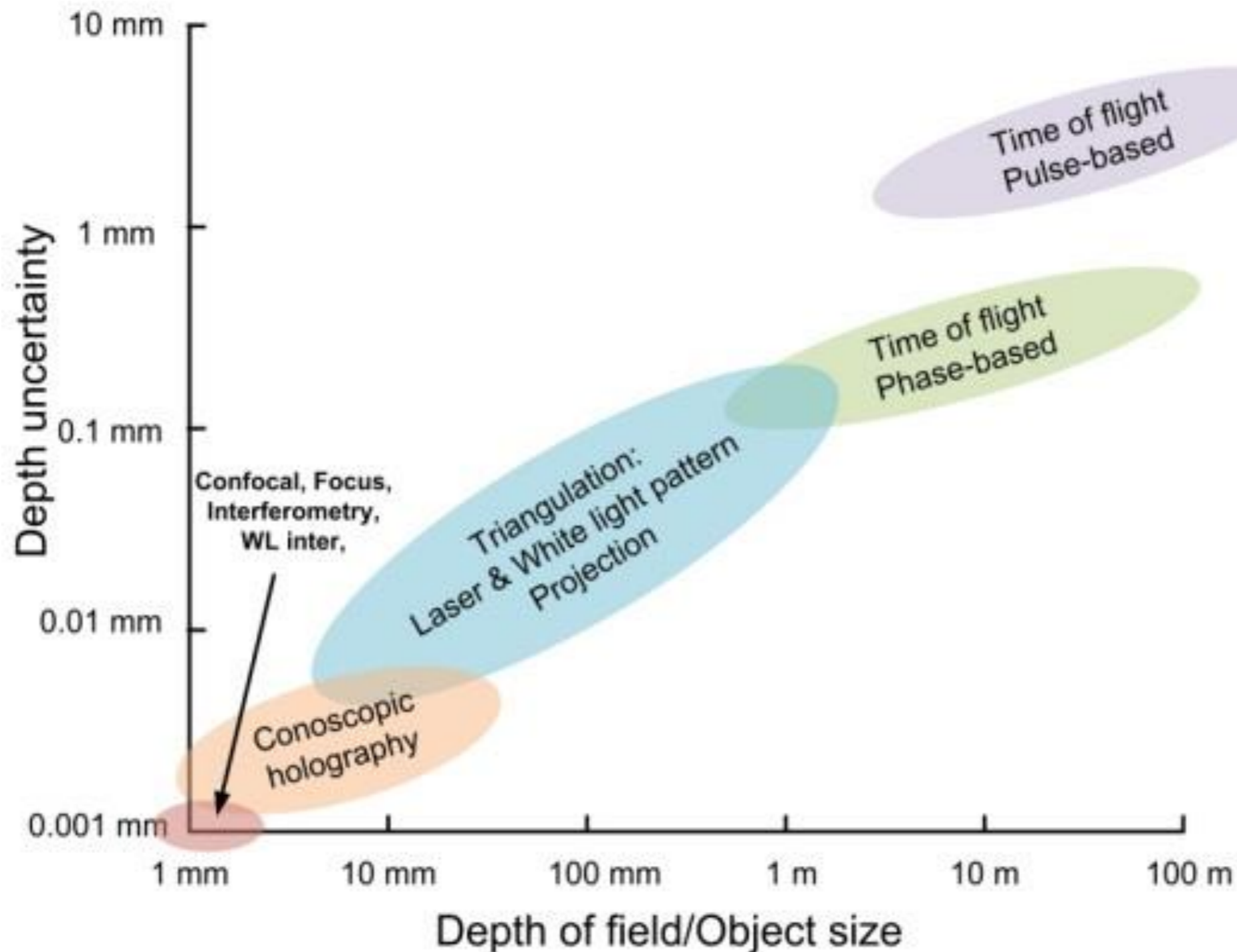

[Drouin et al., 2012]

Confocal Microscopy

- Increase the optical resolution and contrast of microscope by placing a pinhole at the confocal plane of the lens to eliminate out-of-focus light
- Controlled and highly limited depth of focus.
- 3D reconstruction with images captured at different focal plane

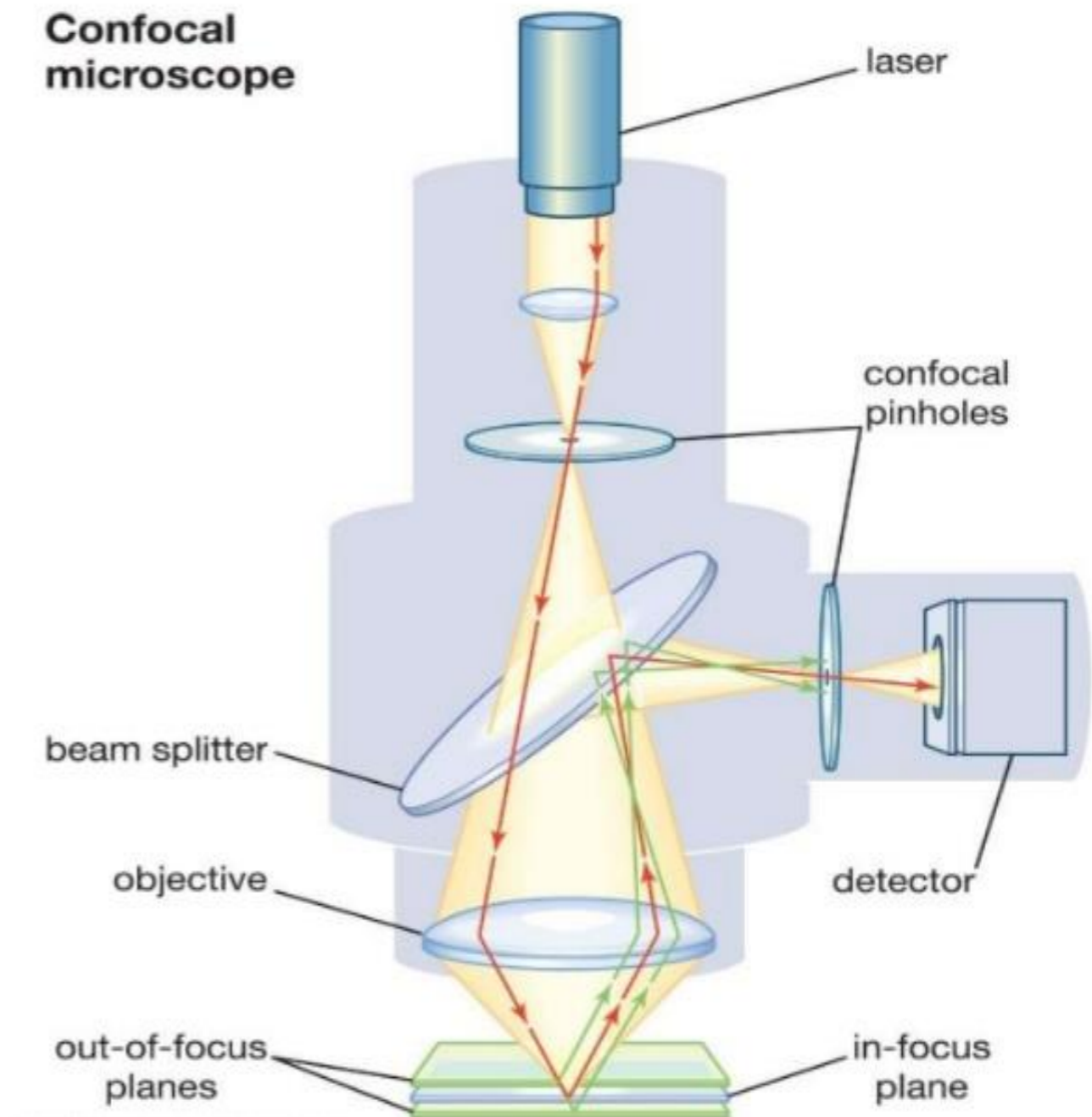

Confocal Microscopy

- Scanning mirrors that can move the laser beam very precisely and quickly (one mirror tilts the beam in the X direction, the other in the Y direction)
- Z-control focus on any focal plane within your sample allowing movement in the axial direction with high precision (>10 nm).

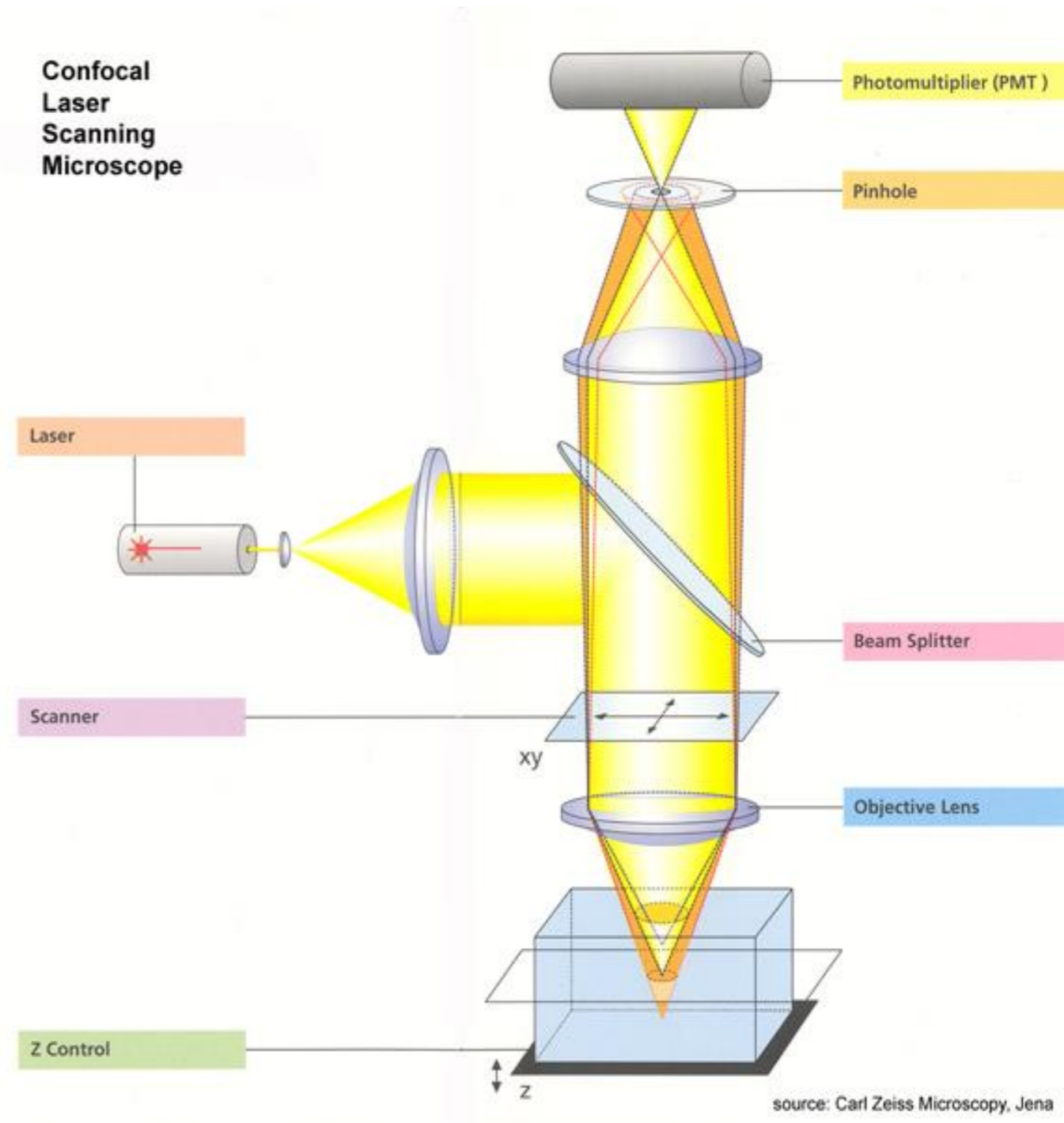

Confocal Microscopy

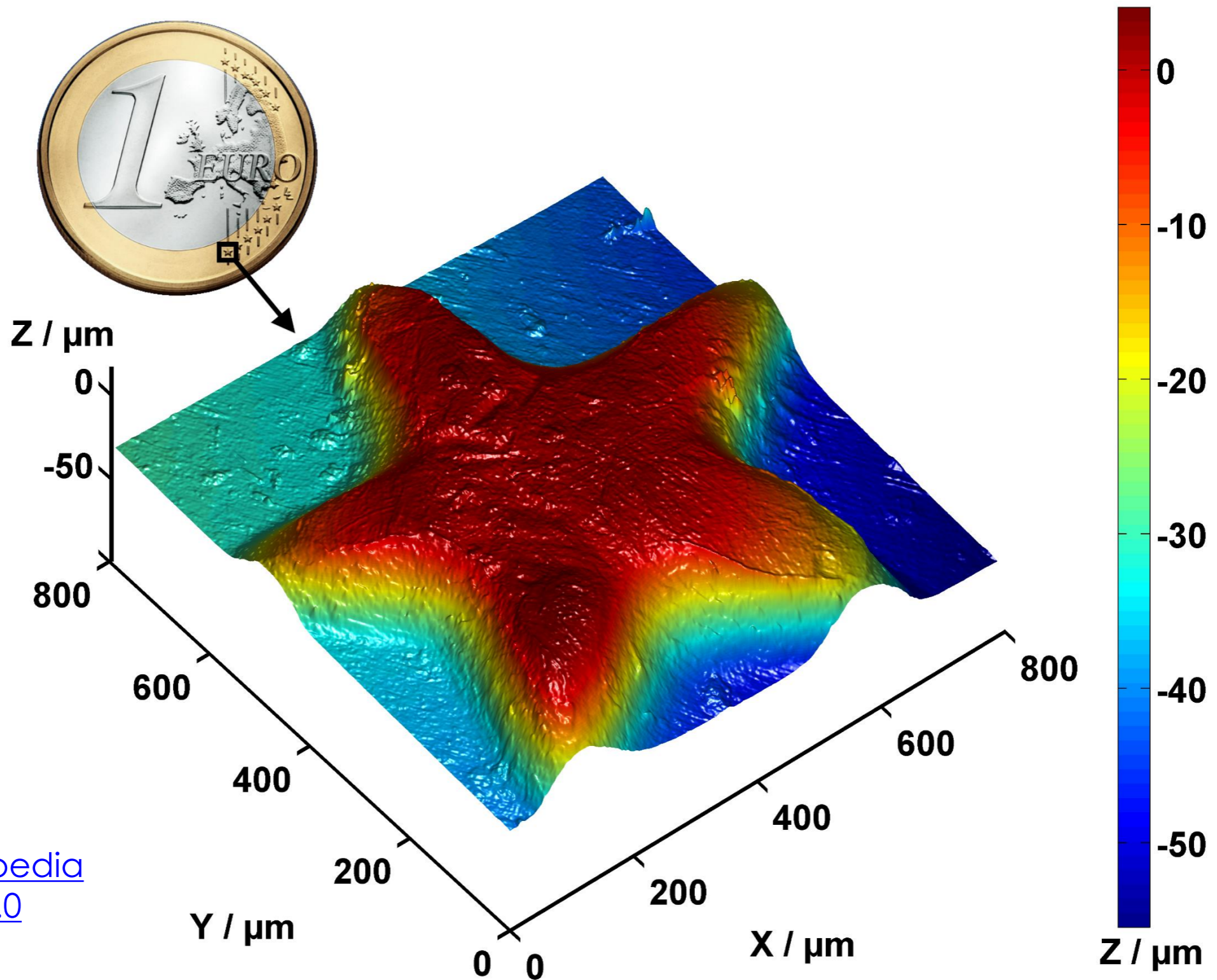

[Image by Wikipedia](#)
[CC BY-SA 3.0](#)

Interferometry

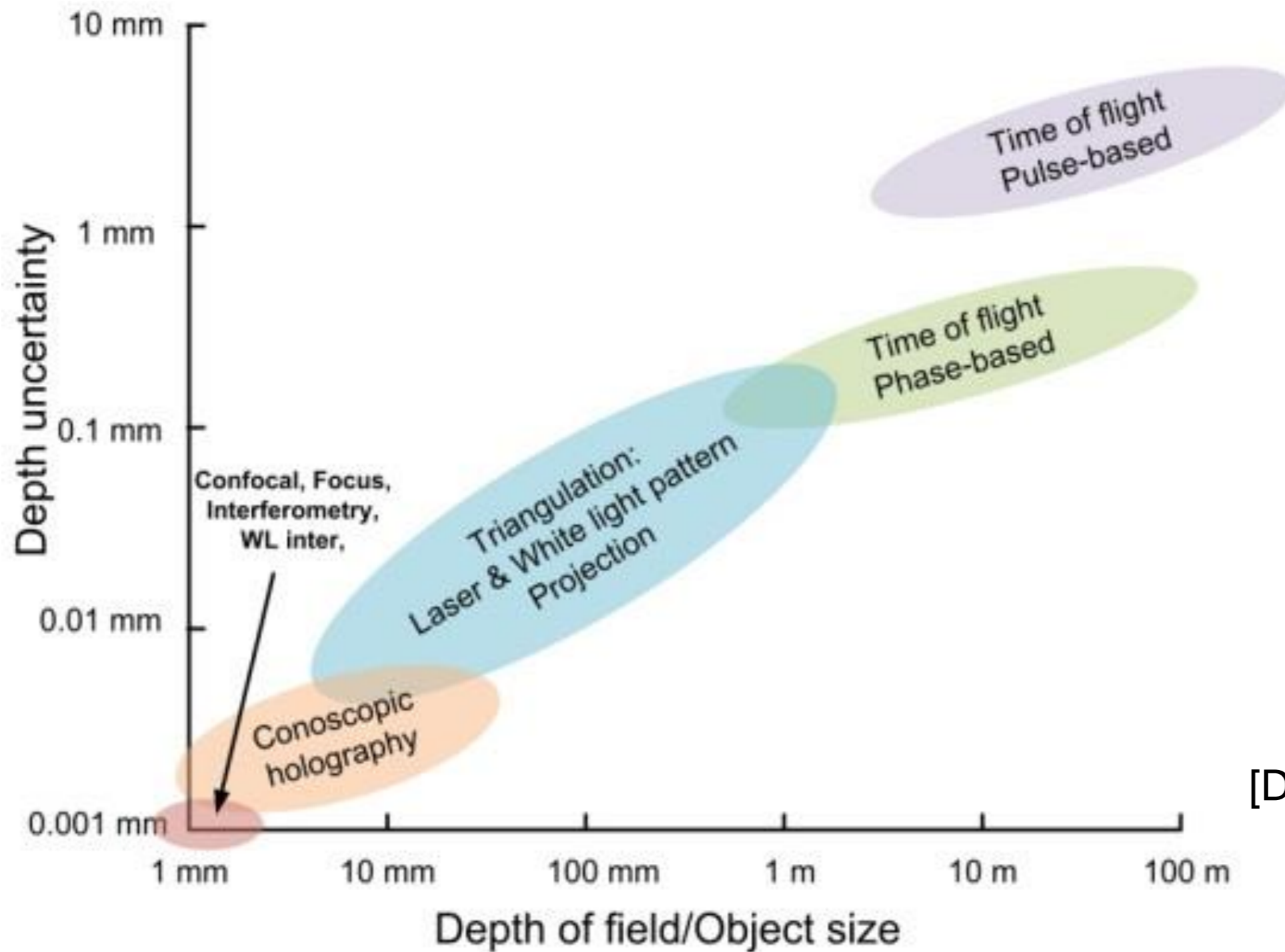

[Drouin et al., 2012]

Inteferometry

- **General Idea** - Superimposing waves causing the phenomenon of interference. To extract information from the resulting waves.

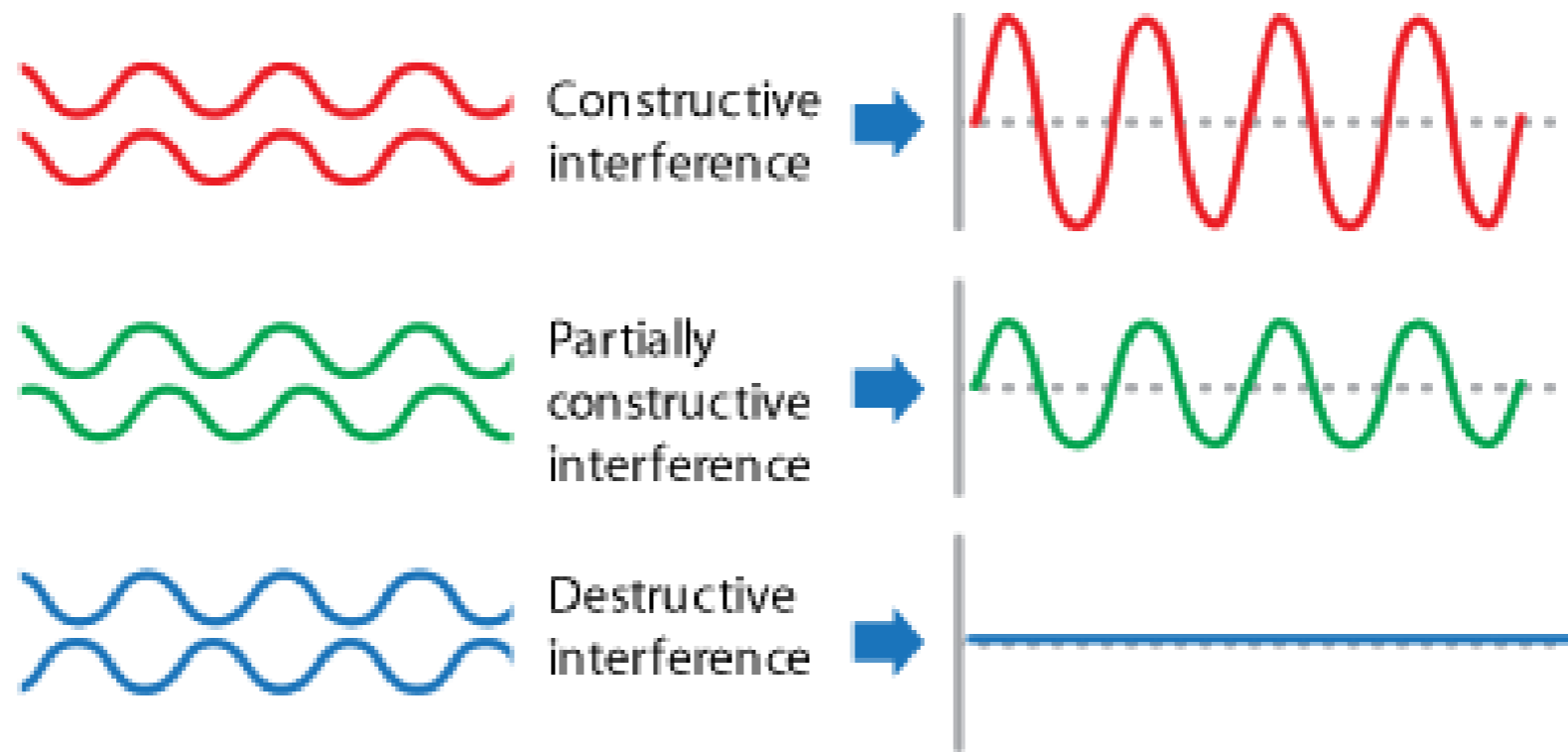

Michelson Interferometer

- Single source split into two beams that travel different path, then combined again to produce interference
- Information about the difference in the path by analyzing the interference fringes

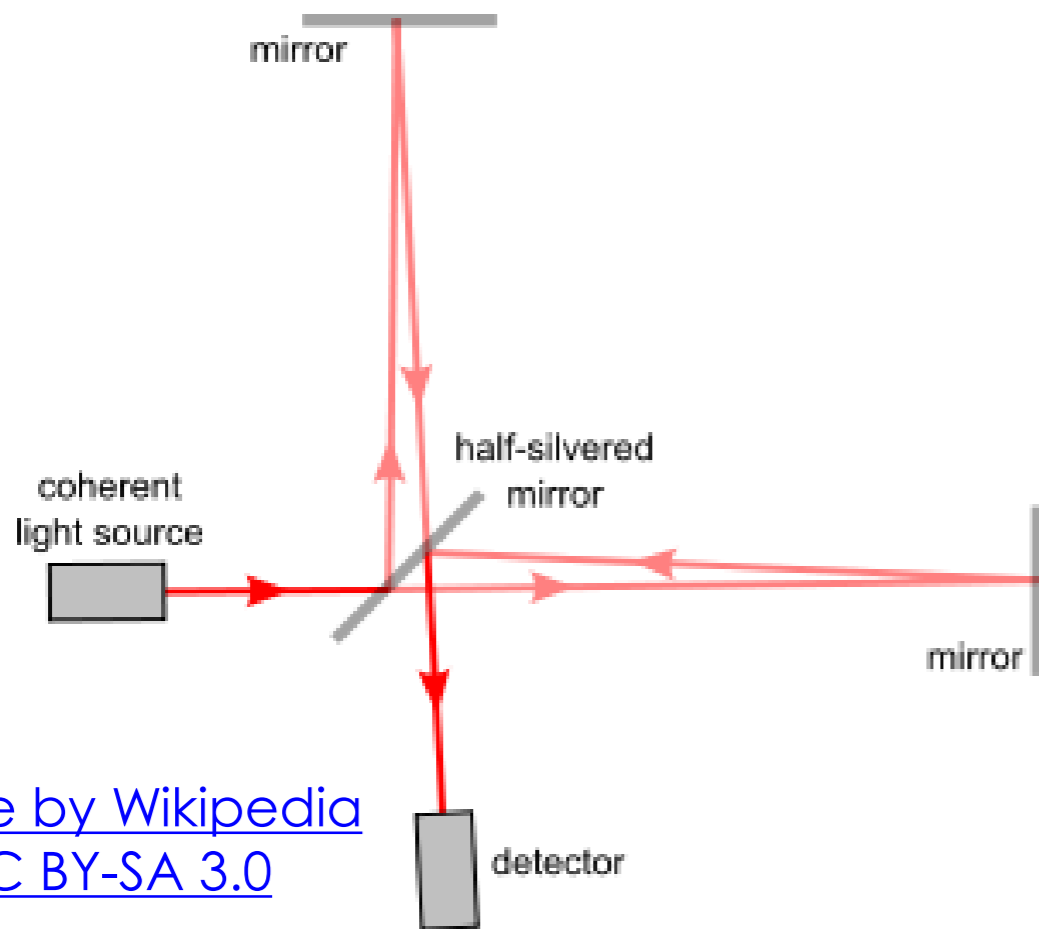

[Image by Wikipedia](#)
[CC BY-SA 3.0](#)

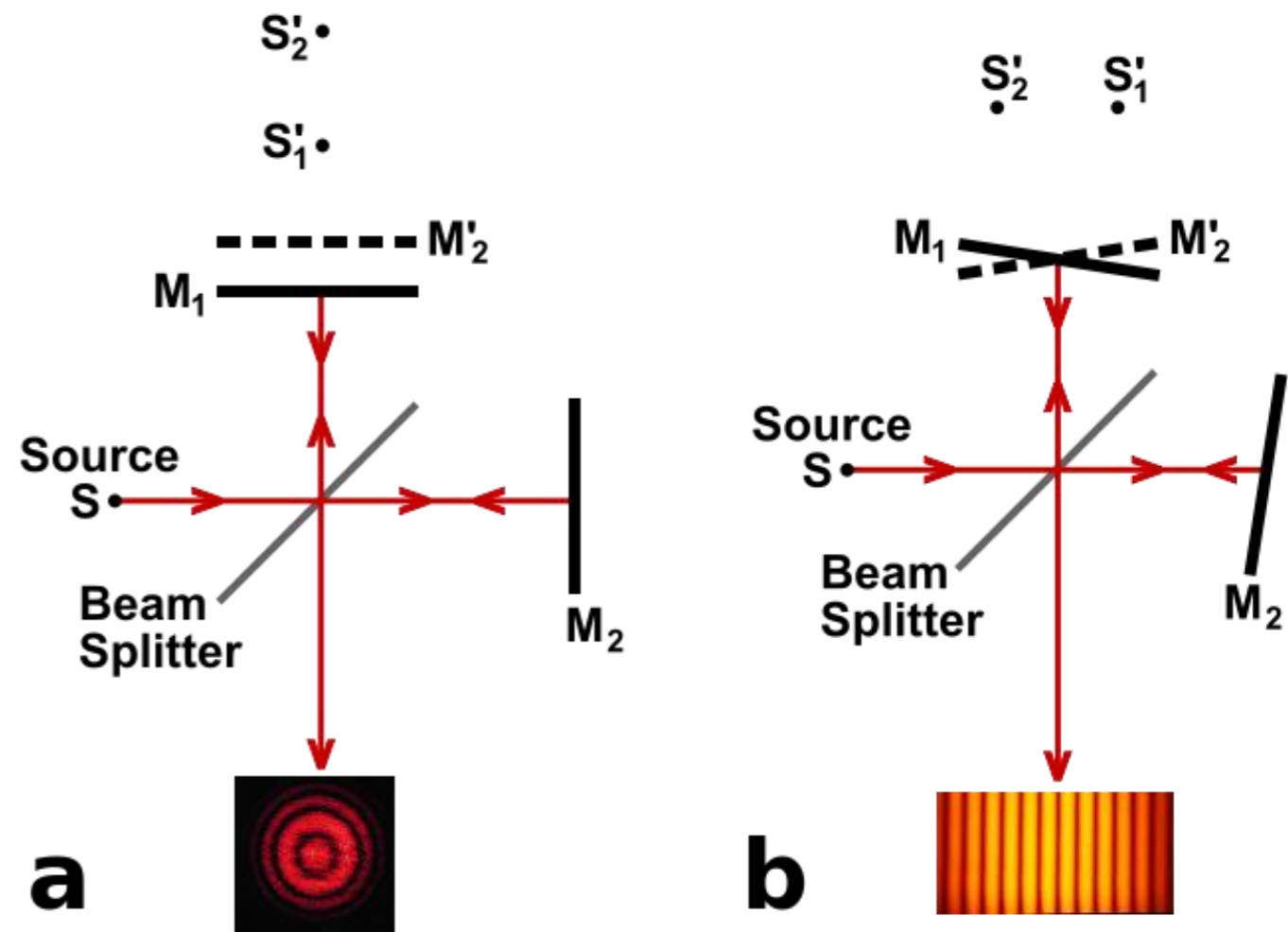

[Image by Wikipedia](#) [CC BY-SA 3.0](#)

White Light Interferometry

- Accurate movement of objective in the z axial direction to change length of beam path
- Find the maximum modulation of the interference signal for each pixel

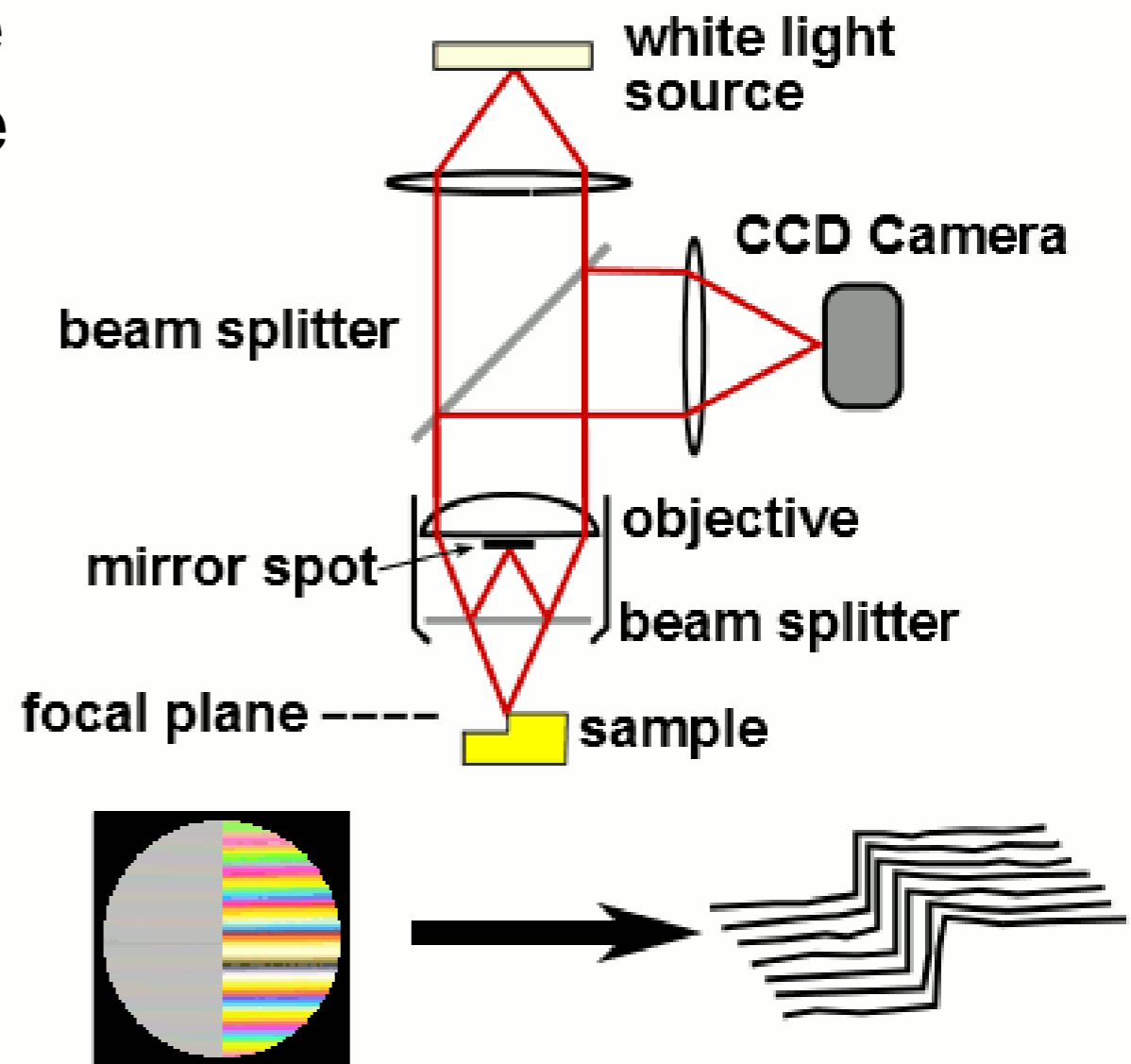
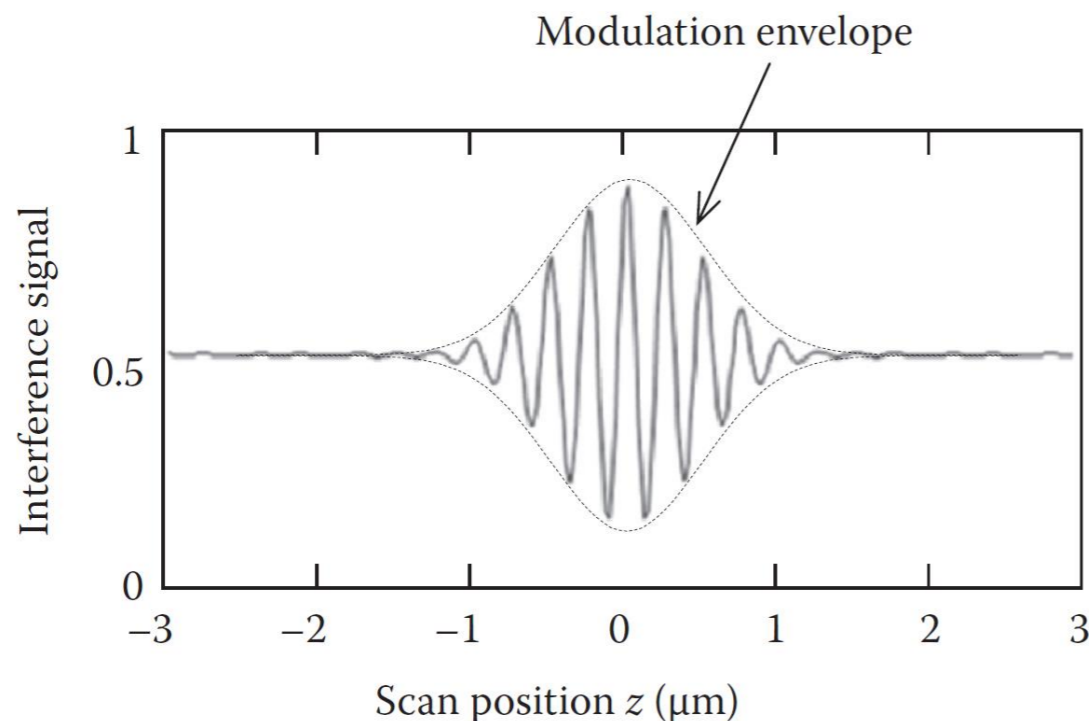

White Light Interferometry

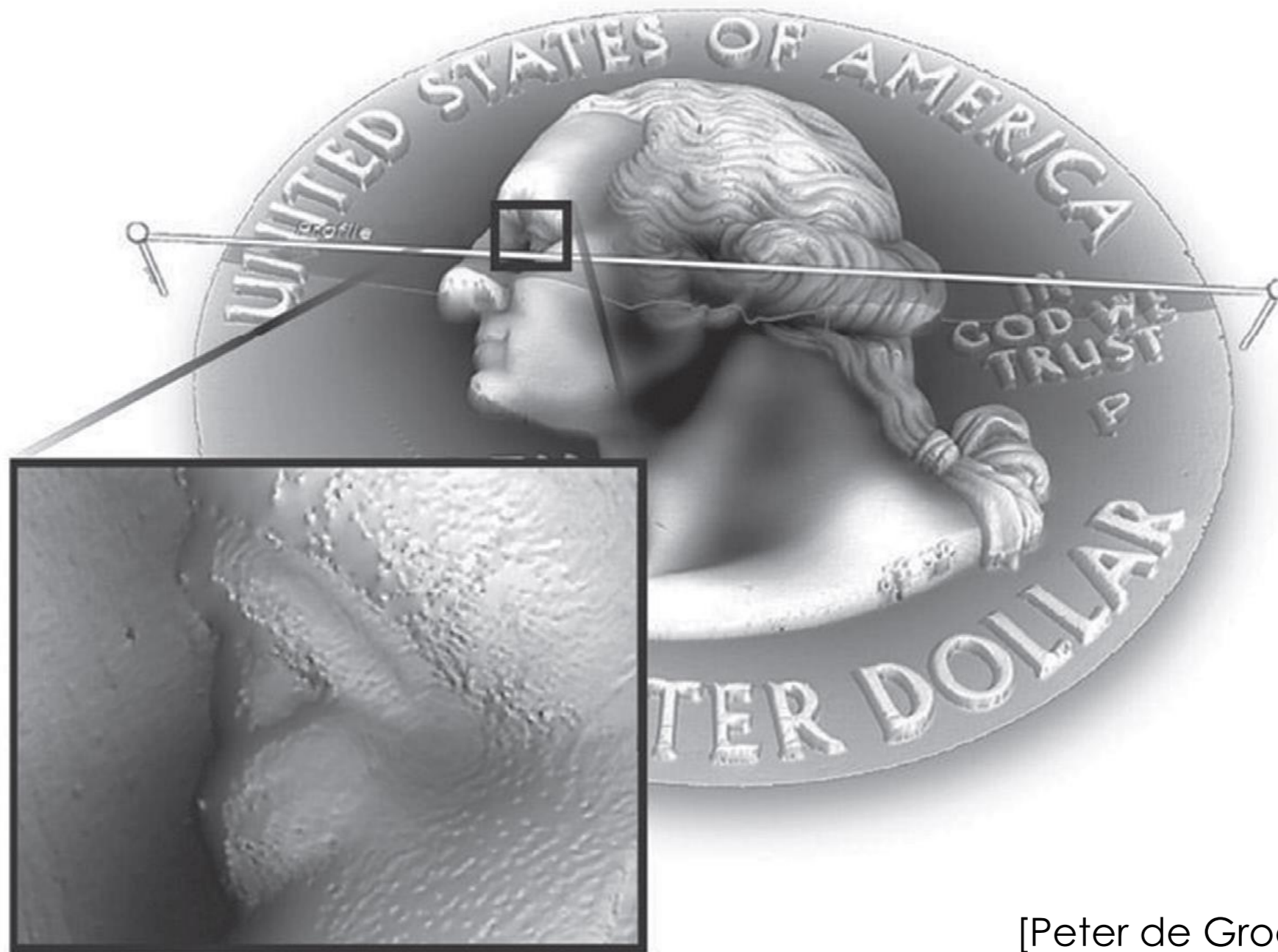

[Peter de Groot, 2015]

Conoscopic Holography

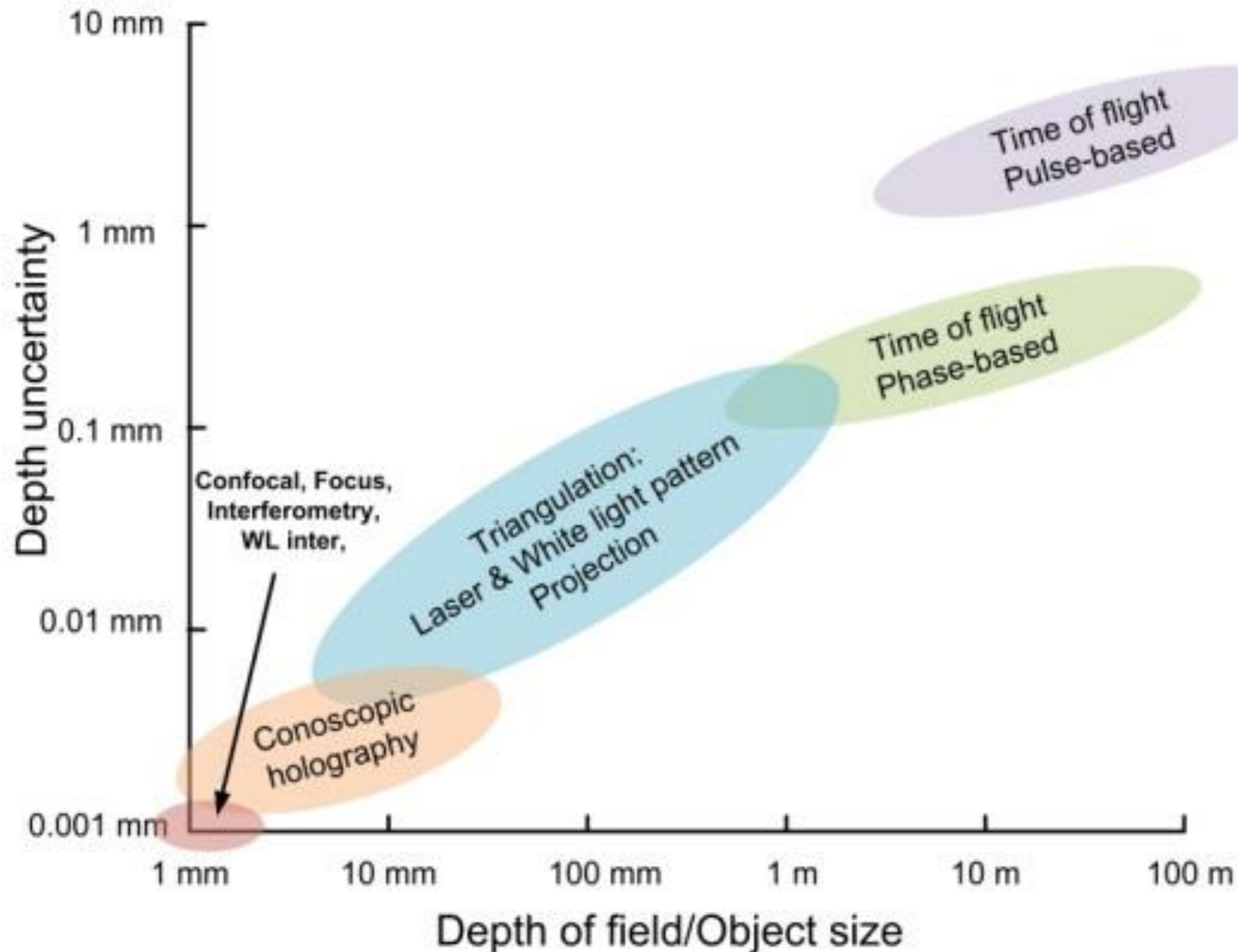

[Drouin et al., 2012]

Conoscopic Holography

Birefringent crystal

- The refractive index depends on the polarization and propagation direction of light. The refractive index in one crystal axis (optical axis) is different from the other.
- Splitting of the incident ray in two rays with different paths according to polarization
 - Ordinary ray (a constant refractive index)
 - Extraordinary ray (the refractive index depends on the ray direction)

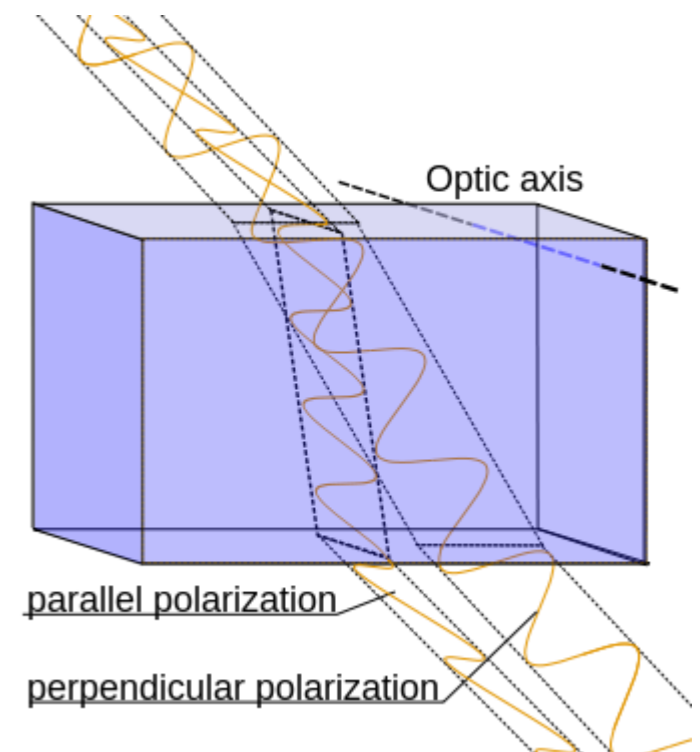

Conoscopic Holography

- Analyzing the interference pattern of ordinary and extraordinary waves of the beam reflect by the measured same

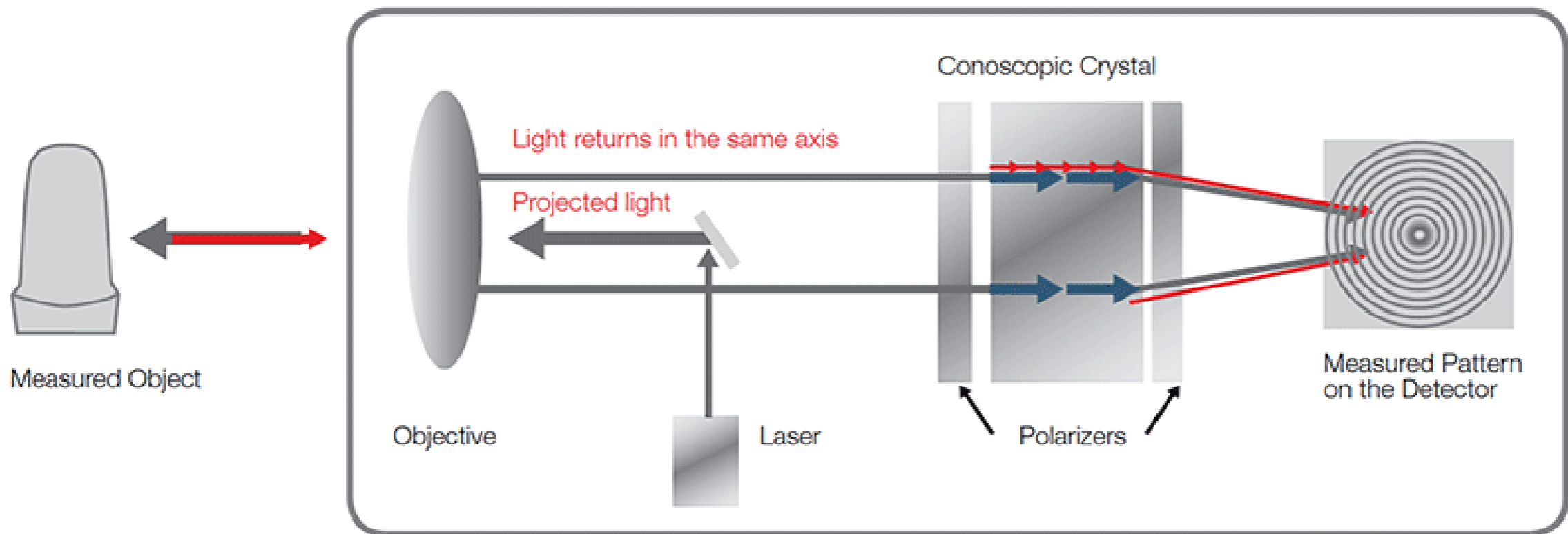

Polarized light moves in different speed as result of distance

Large amount of information on each measurement

Conoscopic Holography

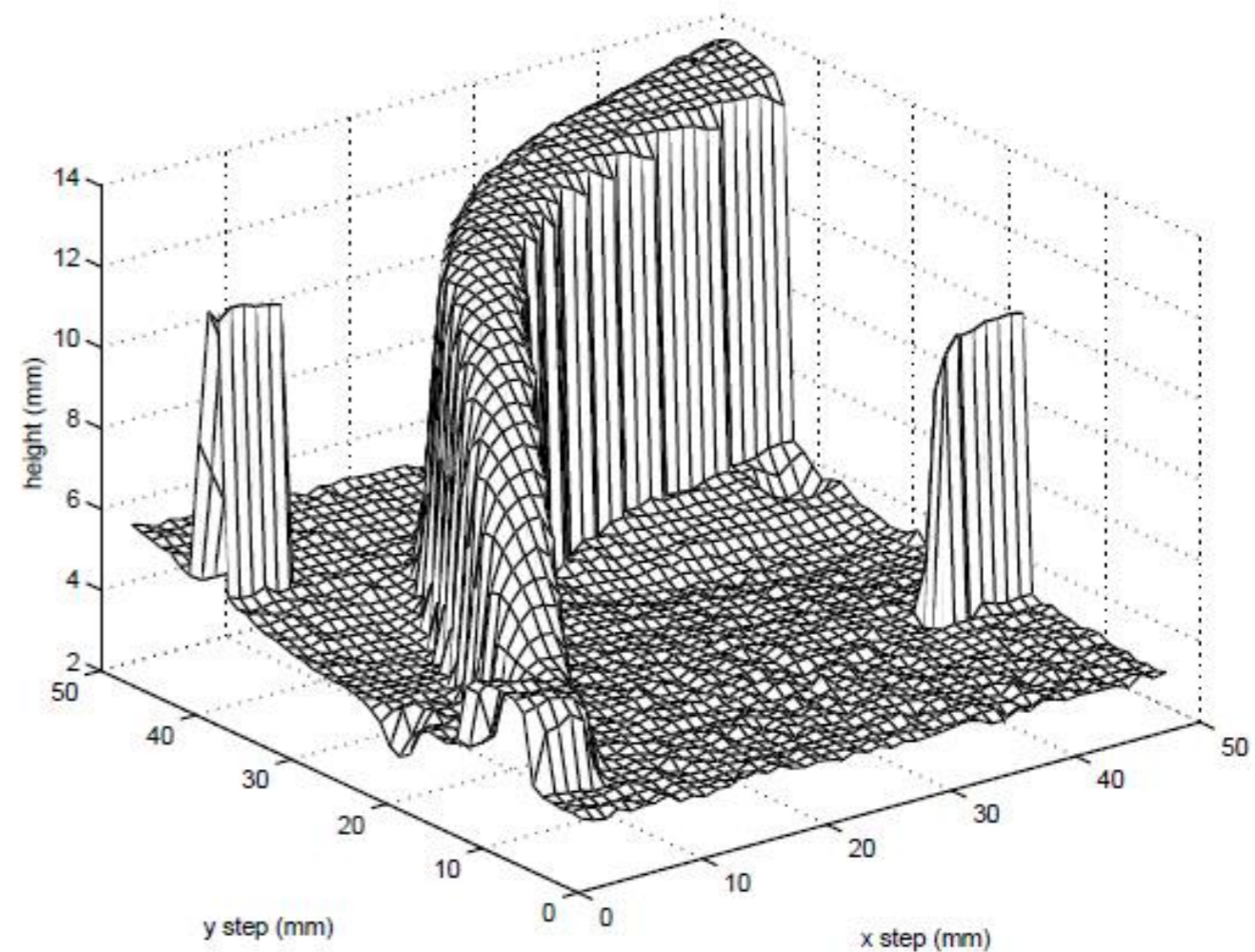
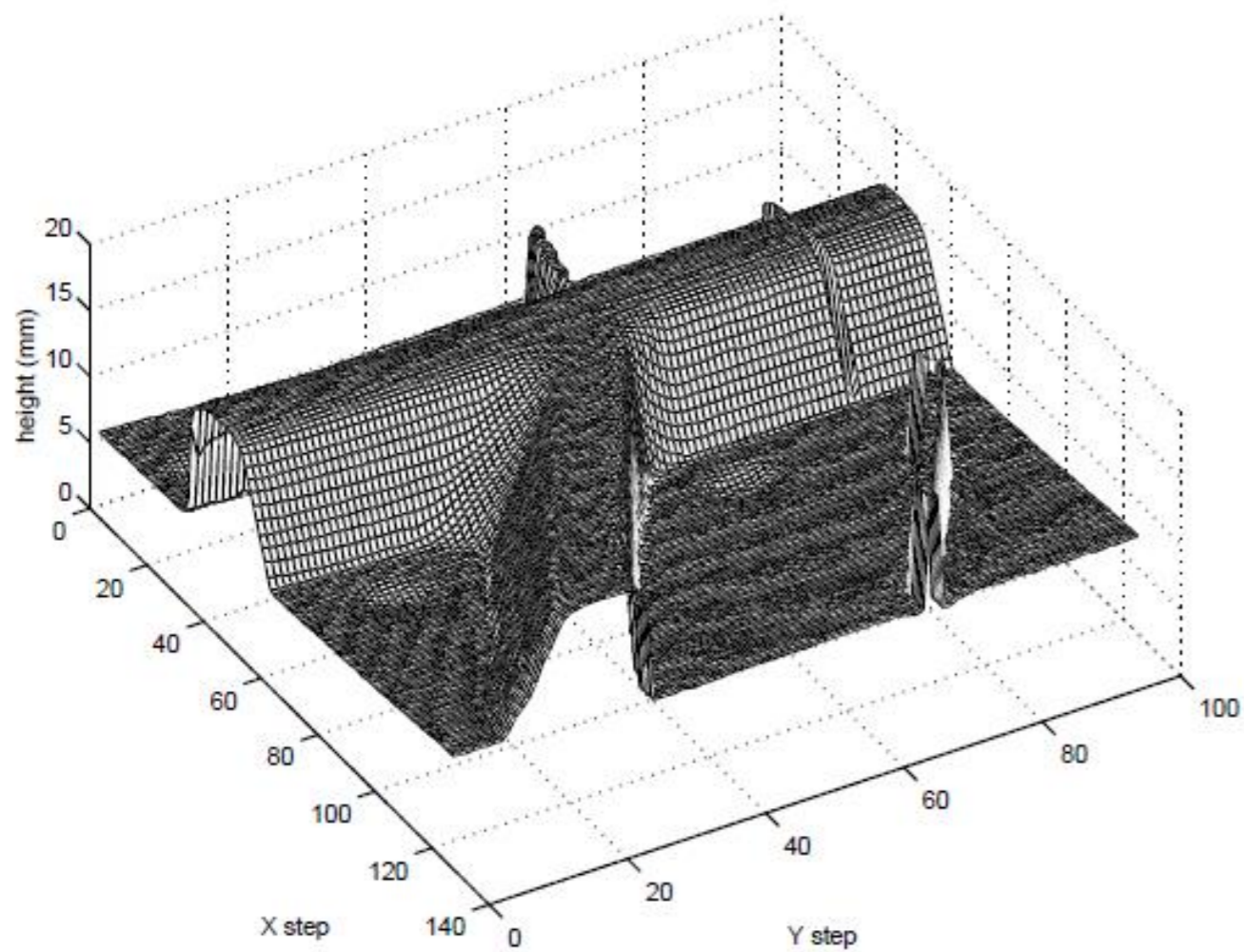

Laser Triangulation

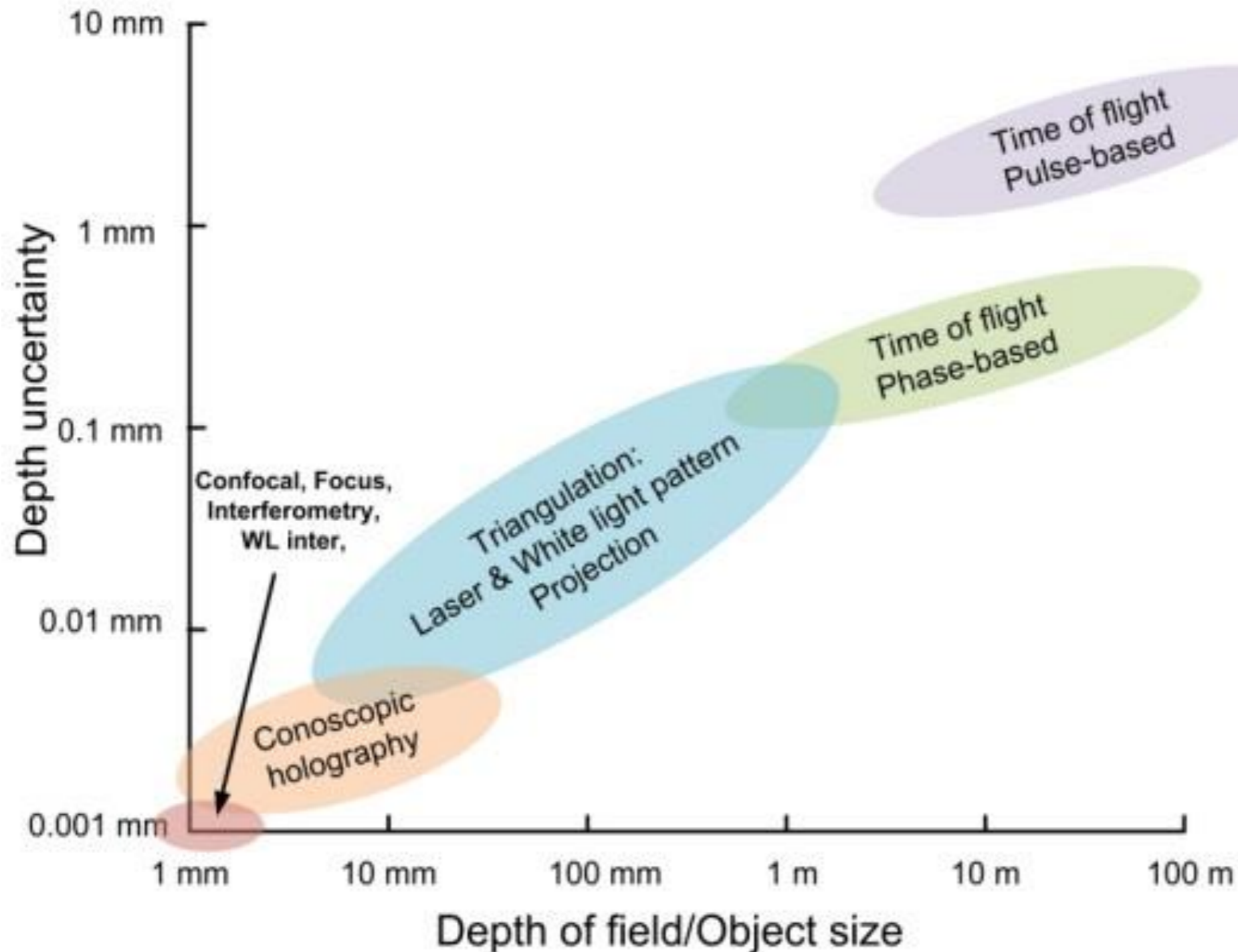

[Drouin et al., 2012]

Triangulation based system

- Location of a point by triangulation knowing the distance between the sensors (camera and light emitter) and the angles between the rays and the base distance

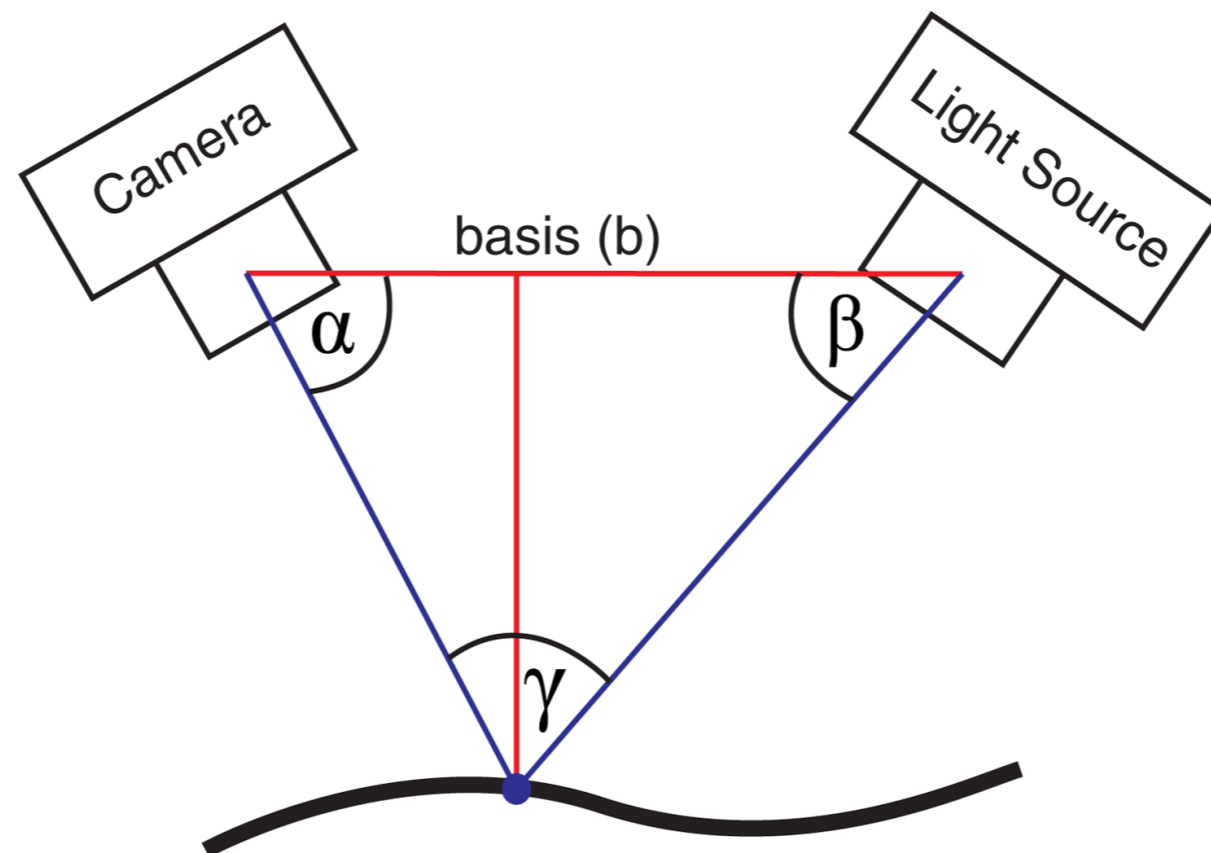

Triangulation based system

- An inherent limitation of the triangulation approach: non-visible regions
- Some surface regions can be visible to the emitter and not-visible to the receiver, and vice-versa
- In all these regions we miss sampled points
- Need integration of multiple scans

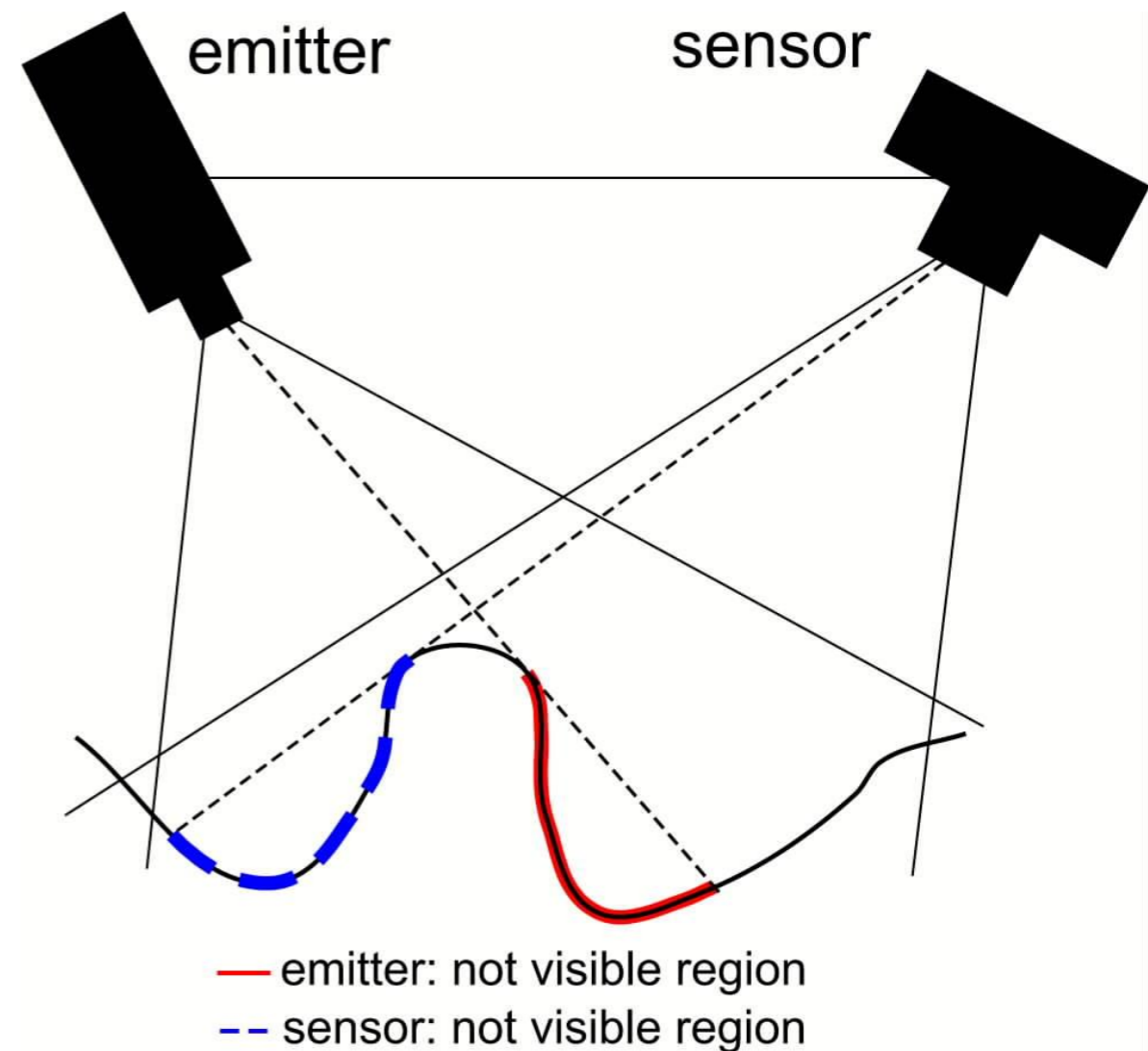

Conoscopic Holography vs Triangulation

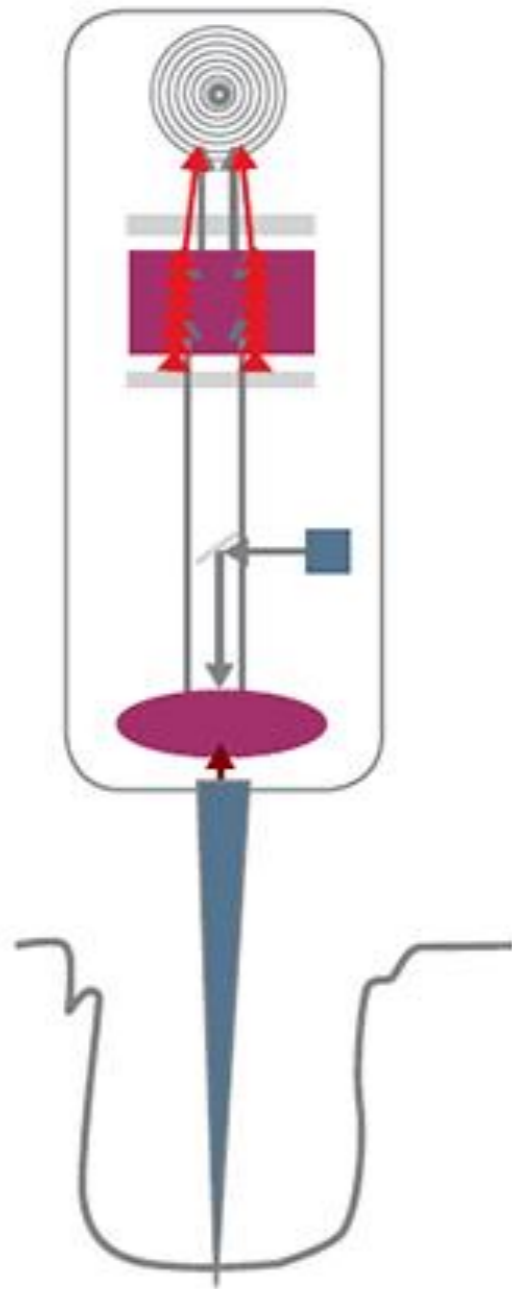

CONOSCOPIC HOLOGRAPHY

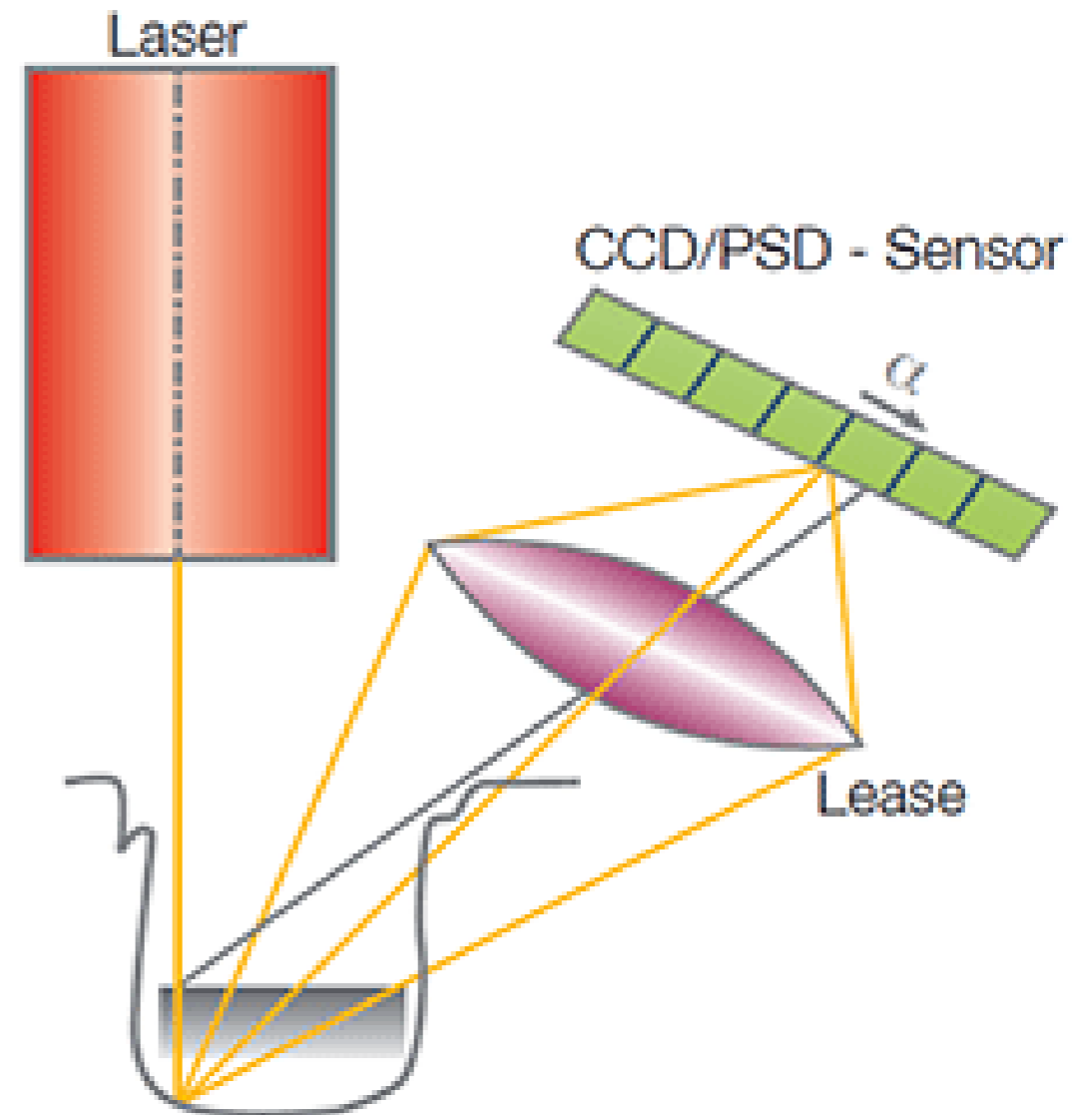

TRIANGULATION

Mathematics of triangulation

[Douglas et al.,
SIGGRAPH 2009]

Parametric representation of lines and rays

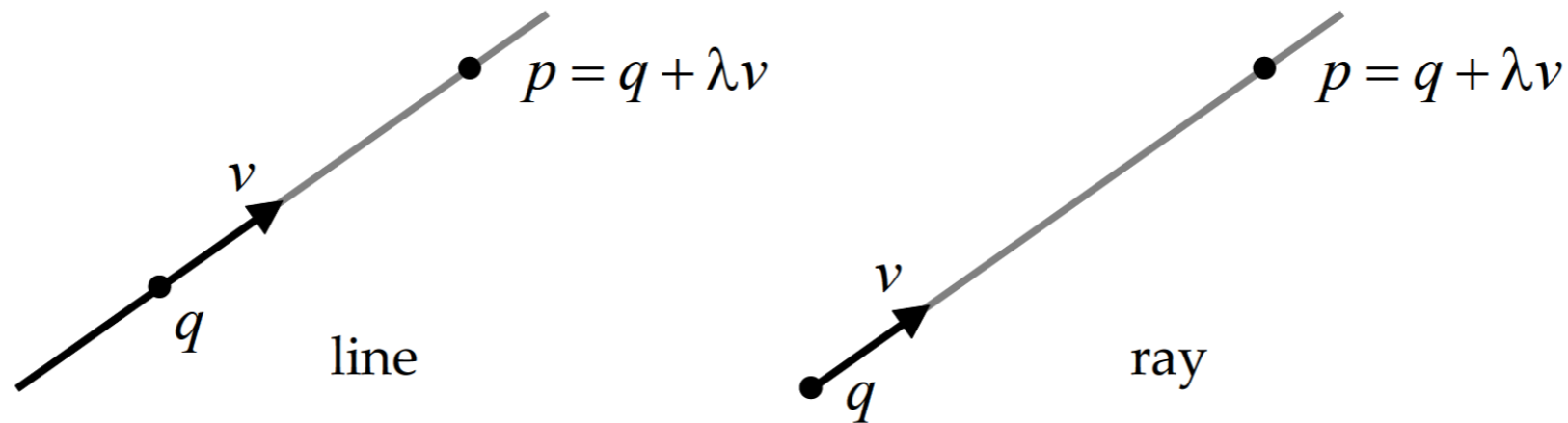

Parametric and implicit representation of a plane

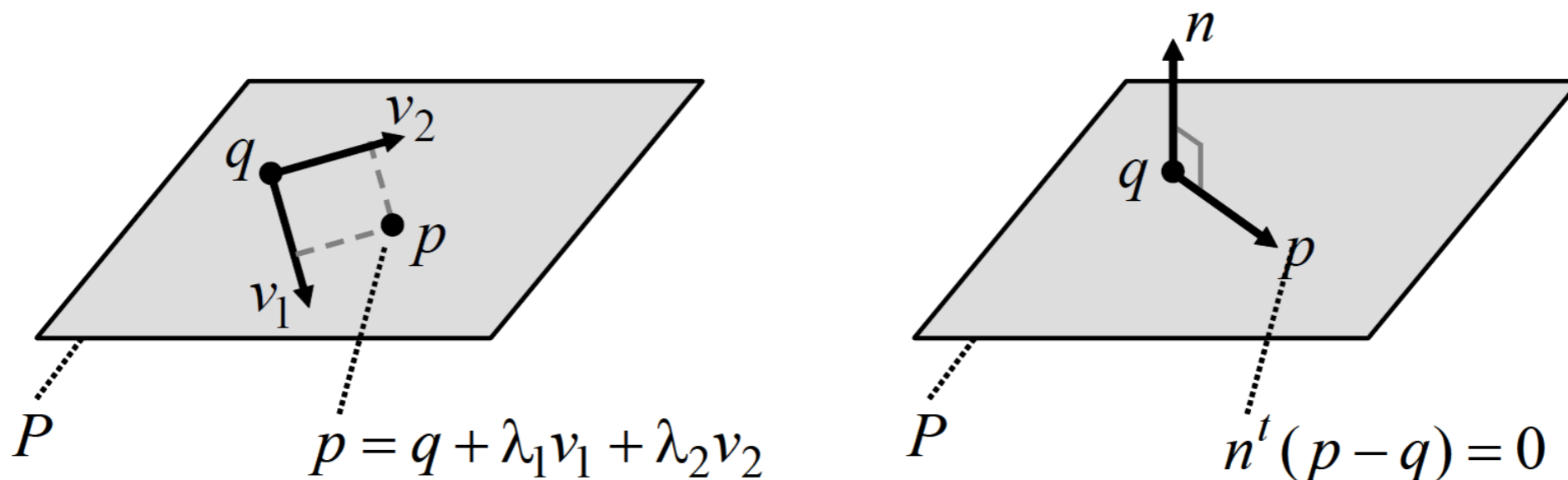

Mathematics of triangulation

[Douglas et al.,
SIGGRAPH 2009]

Ray-plane intersection

$$n^t(p - q_p) = n^t(\lambda v + q_L - q_p) = 0$$



$$\lambda = \frac{n^t(q_p - q_L)}{n^t v}$$

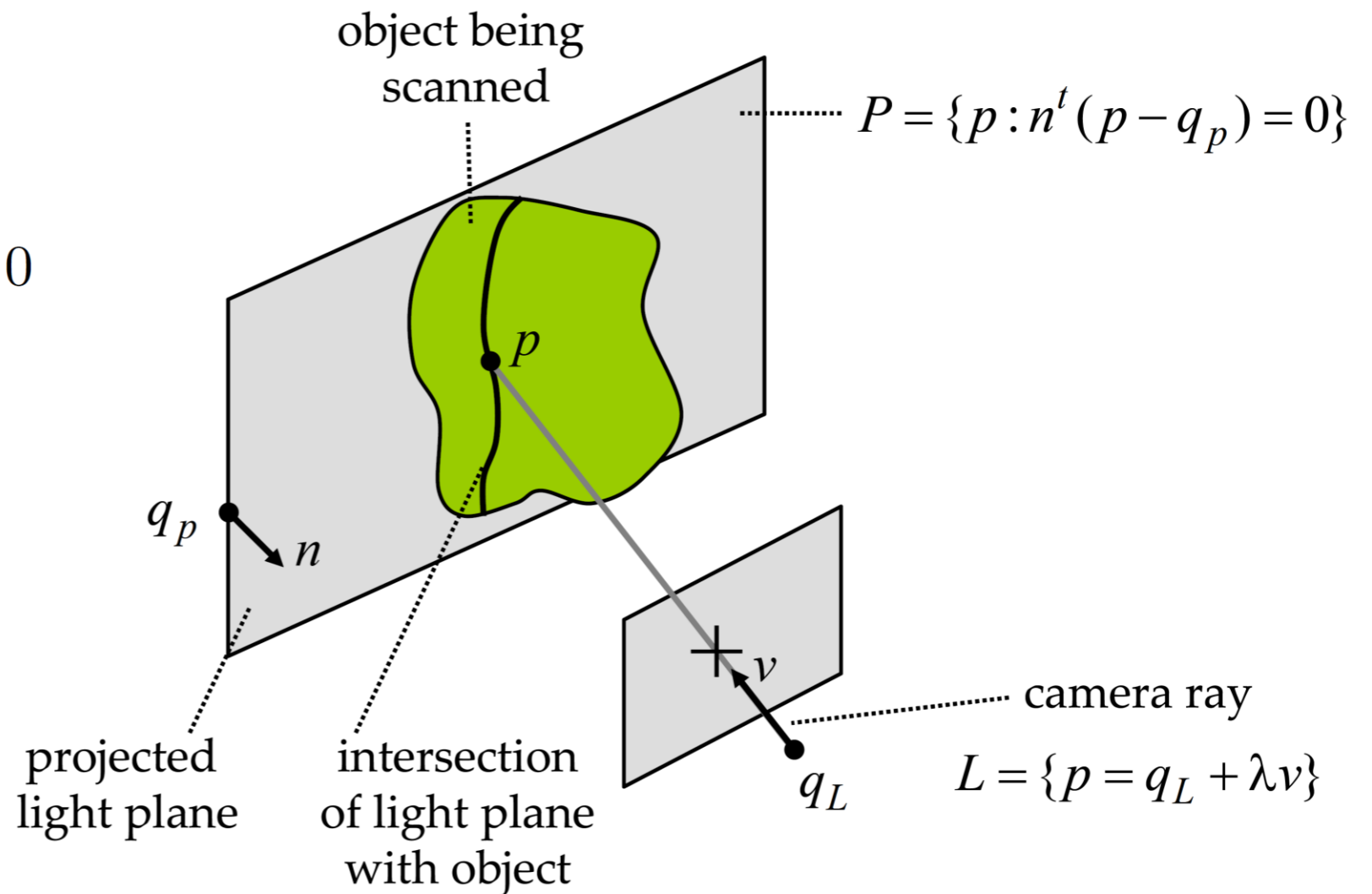

Mathematics of triangulation

[Douglas et al.,
SIGGRAPH 2009]

Ray-ray intersection

$$q_1 + \lambda_1 v_1 = q_2 + \lambda_2 v_2$$

Intersection that
minimizes the sum
of the squared
distance to both
the rays

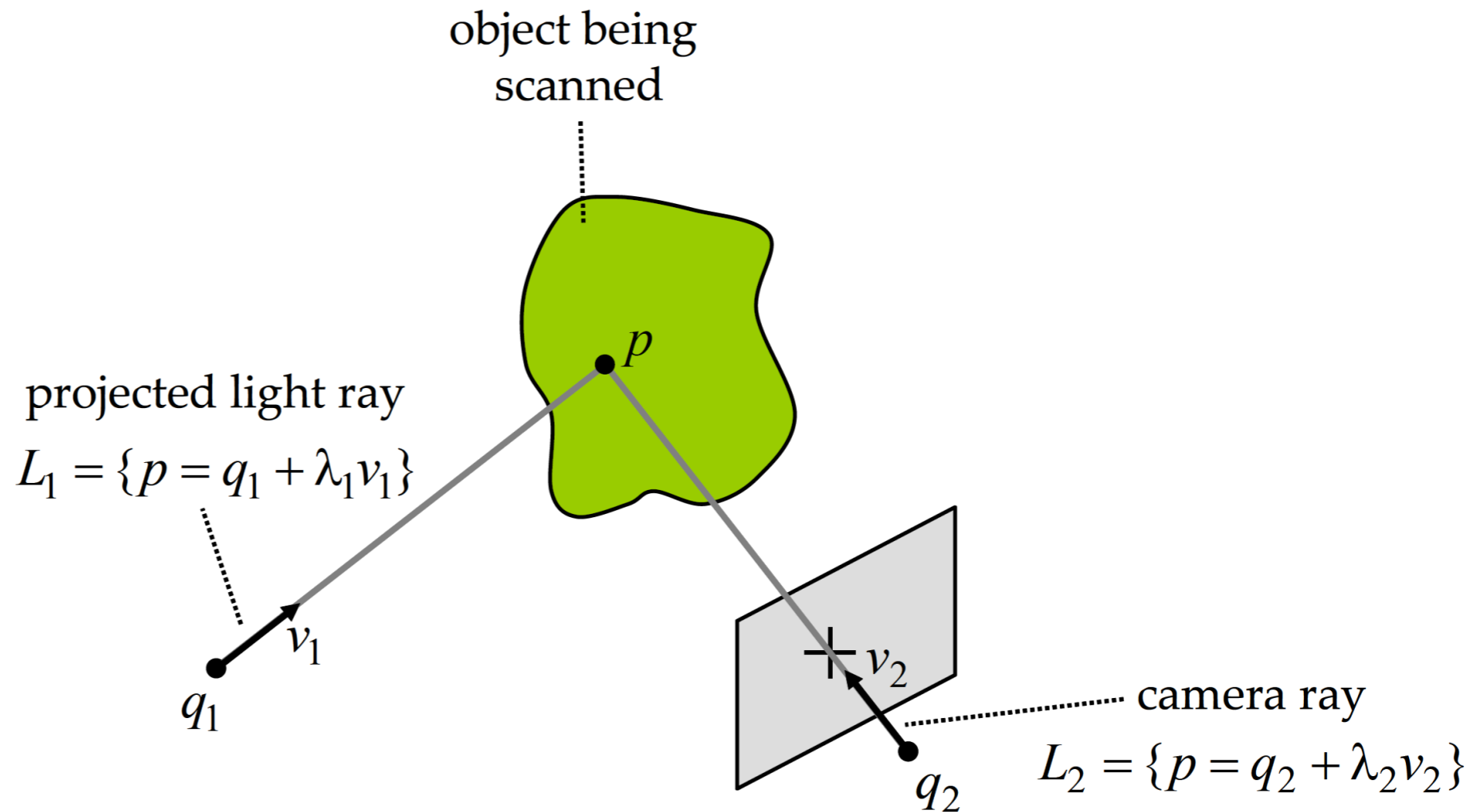

$$\min_{\lambda_1, \lambda_2} \left\| (q_2 + \lambda_2 v_2)^2 - (q_1 + \lambda_1 v_1)^2 \right\|^2 \quad \rightarrow \quad \begin{pmatrix} \lambda_1 \\ \lambda_2 \end{pmatrix} = \begin{pmatrix} \|v_1\|^2 & -v_1^t v_2 \\ -v_2^t v_1 & \|v_2\|^2 \end{pmatrix}^{-1} \begin{pmatrix} v_1^t (q_2 - q_1) \\ v_2^t (q_1 - q_2) \end{pmatrix}$$

Spot Laser Triangulation

- Spot position location (find the most intensity pixel and compute the centroid using the neighbors)

$$p = i_M + \frac{\sum_{i=-N}^N I(i_M + i)i}{\sum_{i=-N}^N I(i_M + i)}.$$



- Triangulation using trigonometry

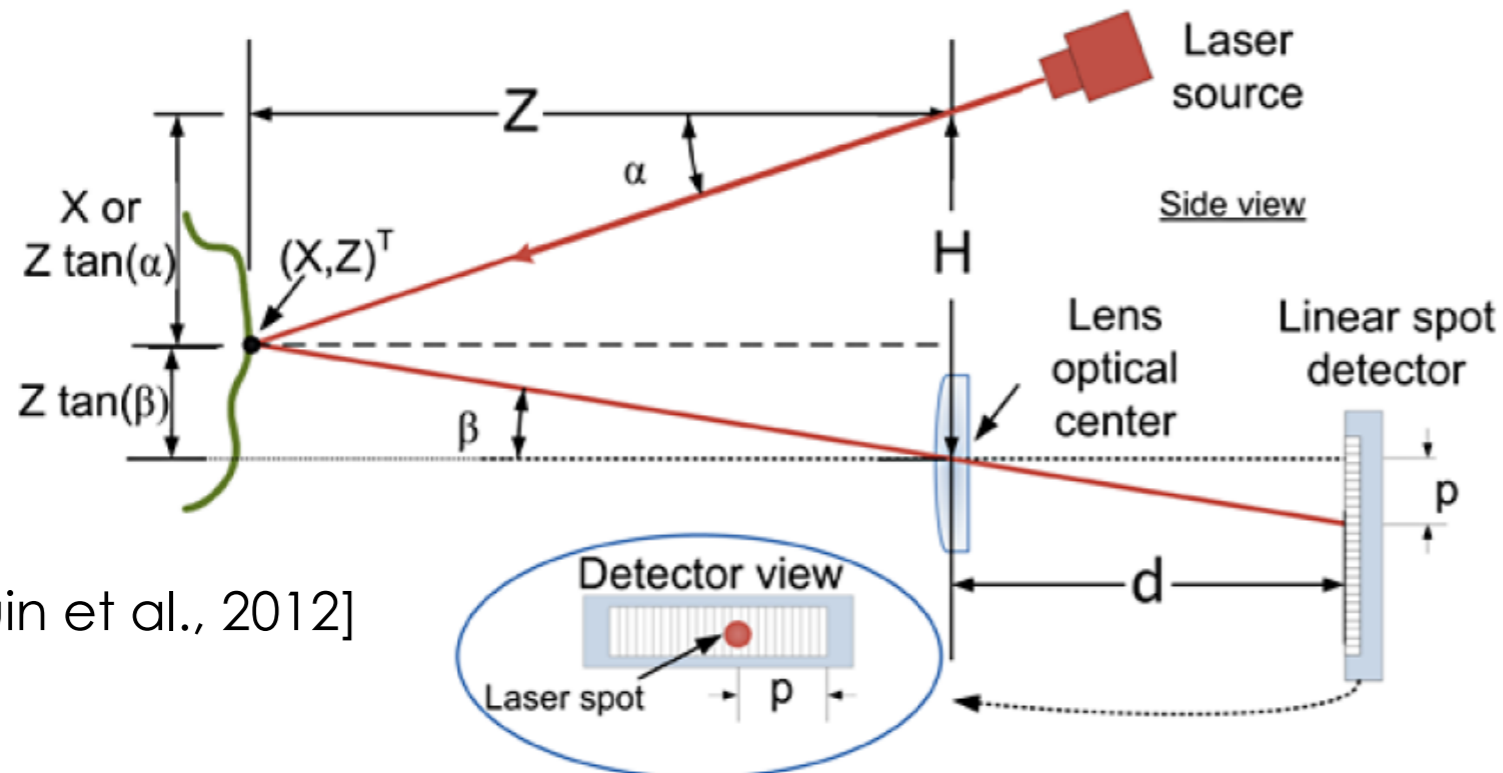

[Drouin et al., 2012]

$$Z = \frac{H}{\tan \alpha + \tan \beta}$$

$$X = Z \tan \alpha$$

Laser Line Triangulation

- Laser projector and camera modelled as a pinhole camera
- Detection of the pixel in the laser line with computer vision algorithm (peak detection)
- Ray-plane triangulation

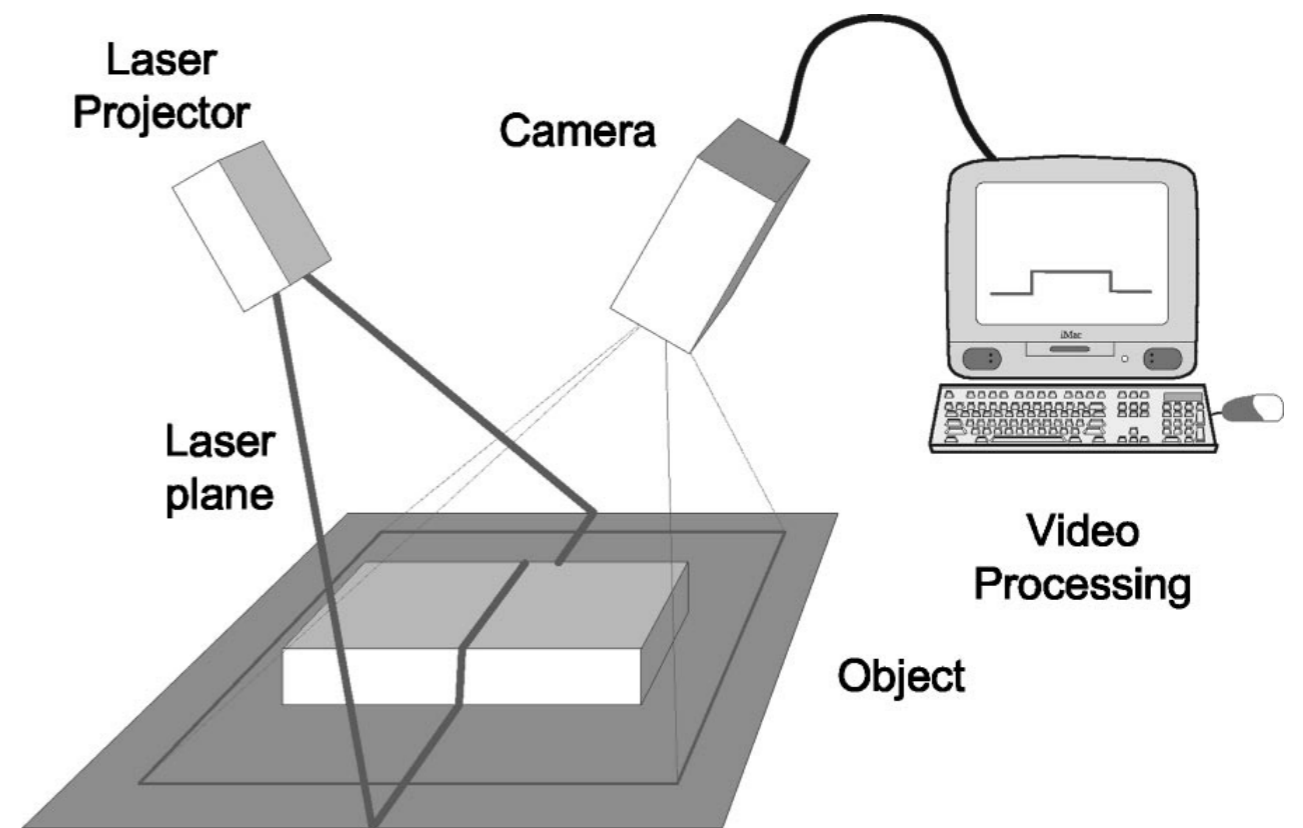

[Blais, 2004]

Laser Line Triangulation

- Rotate or translate the scanner or rotate the object using a turntable

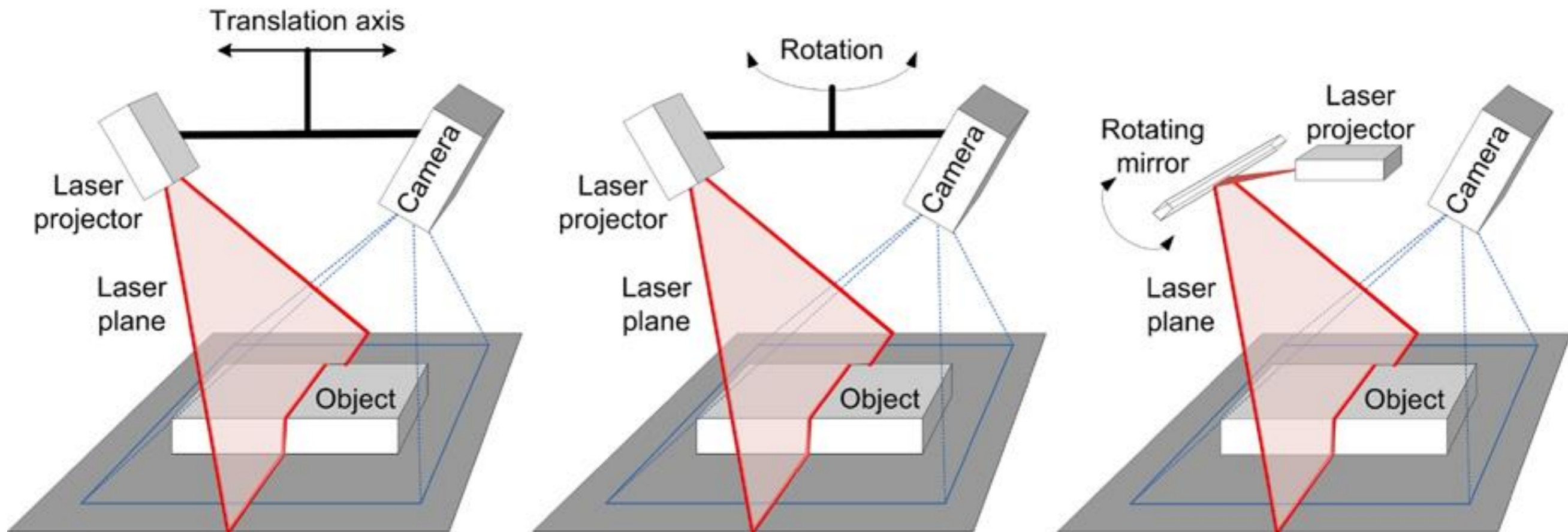

[Drouin et al., 2012]

Errors in Triangulation system

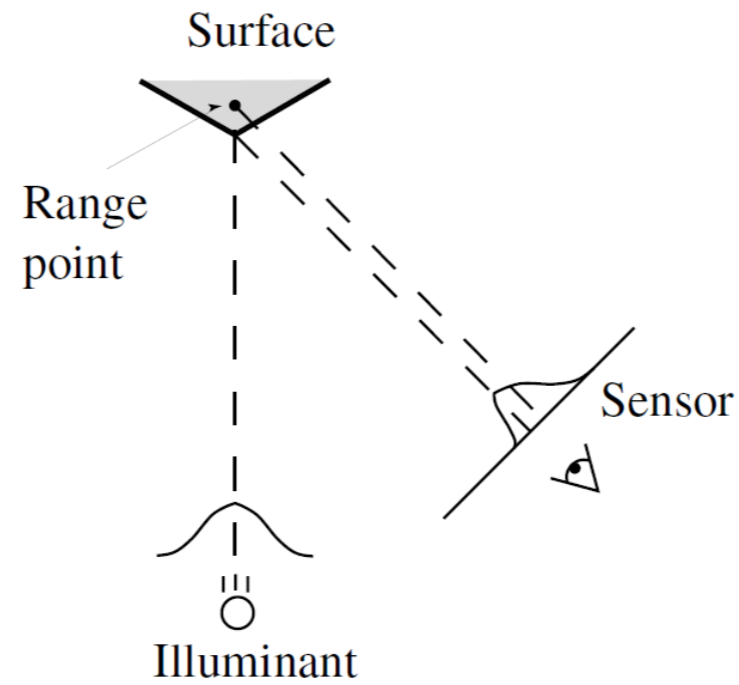
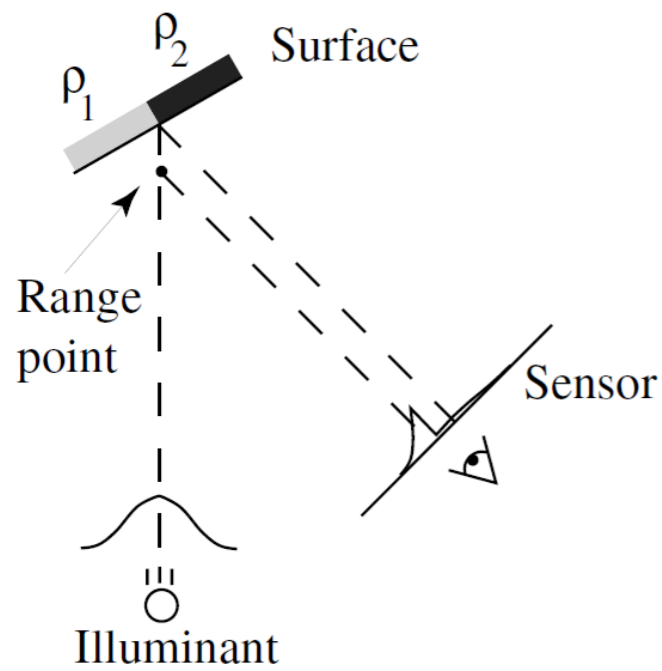

[Curless et al.,
ICCV 1995]

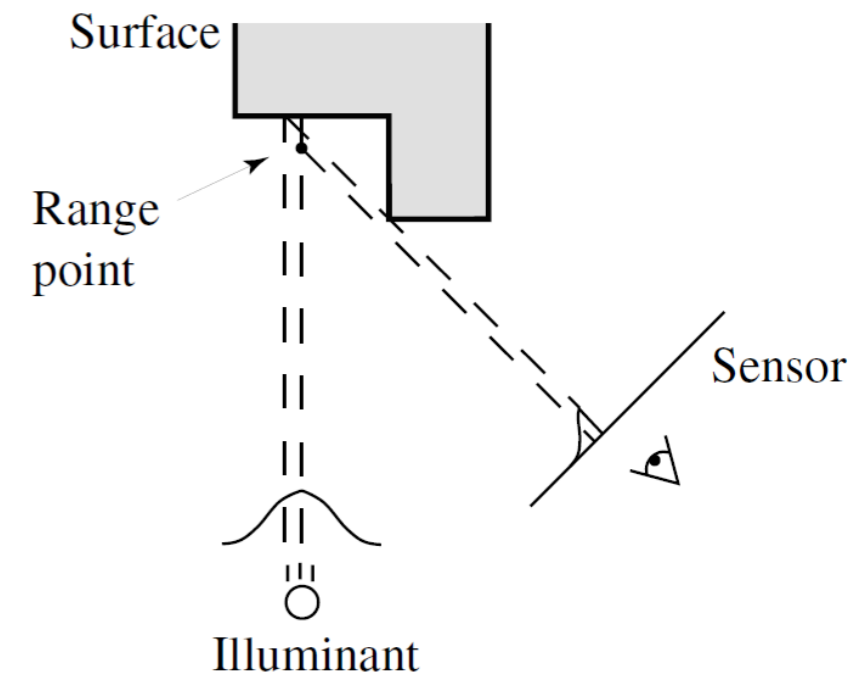
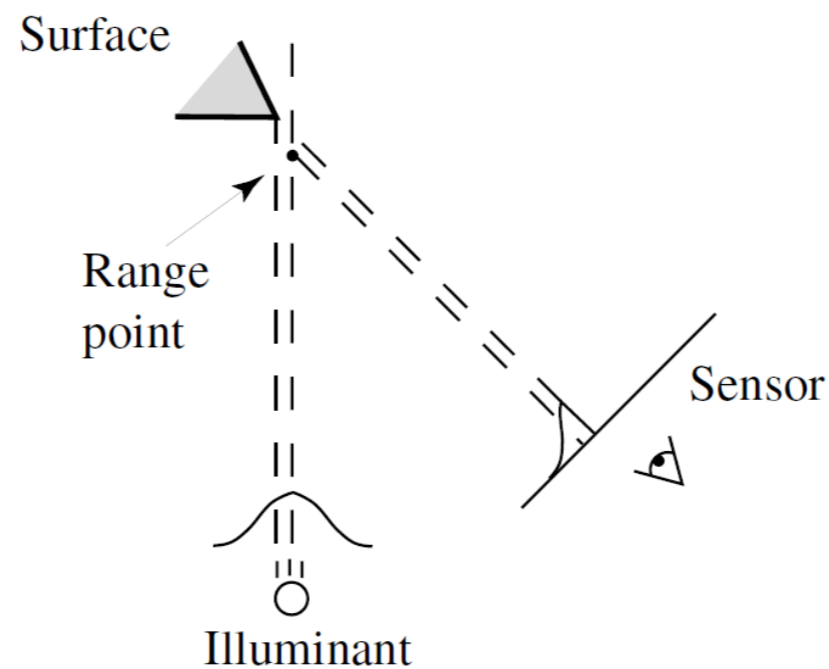

Errors in Triangulation system

- Solution: space-time analysis

[Curless et al., ICCV 1995]

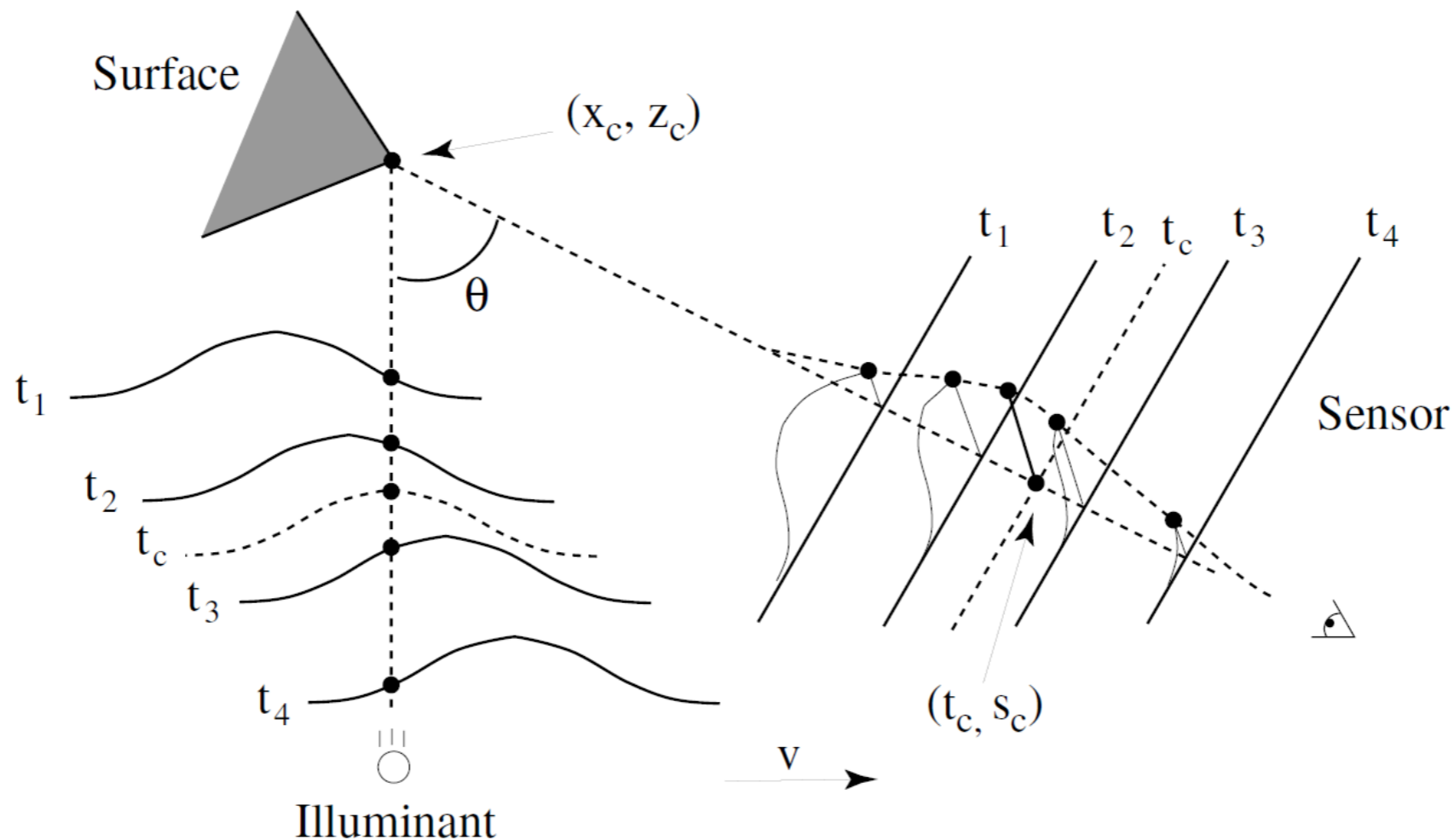

Errors in Triangulation system

- Solution: space-time analysis

[Curless et al., ICCV 1995]

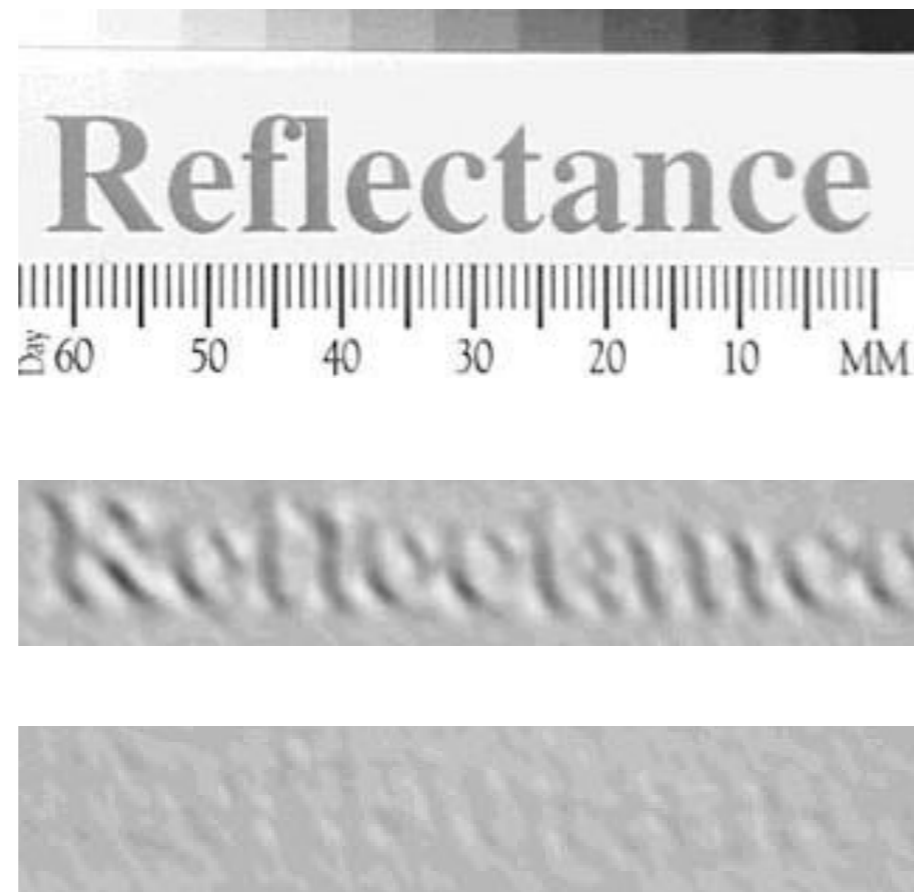

Structured Light

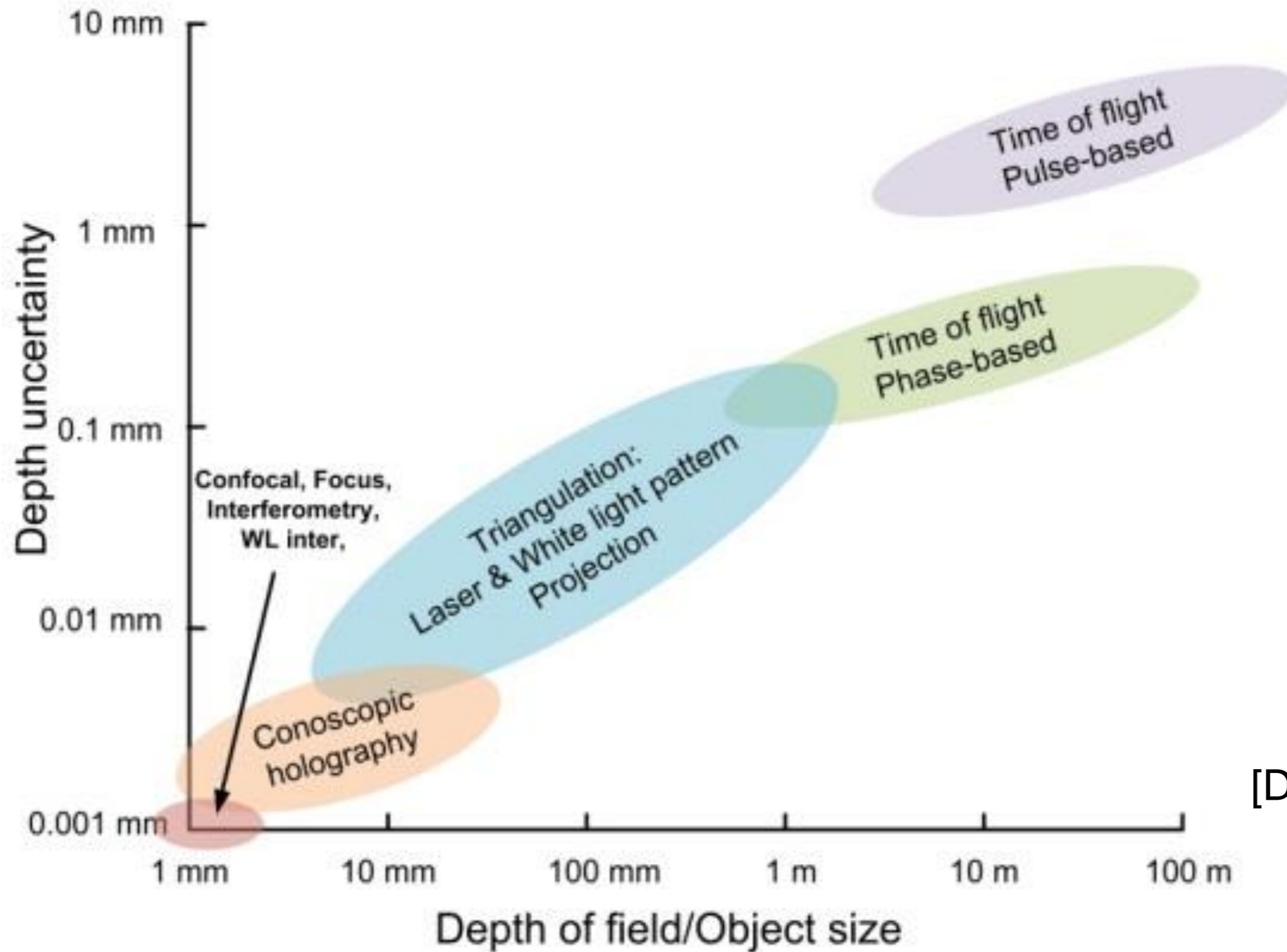

[Drouin et al., 2012]

Structured light scanner

- Projection of light pattern using a digital projector and acquisition of its deformation with one or two cameras

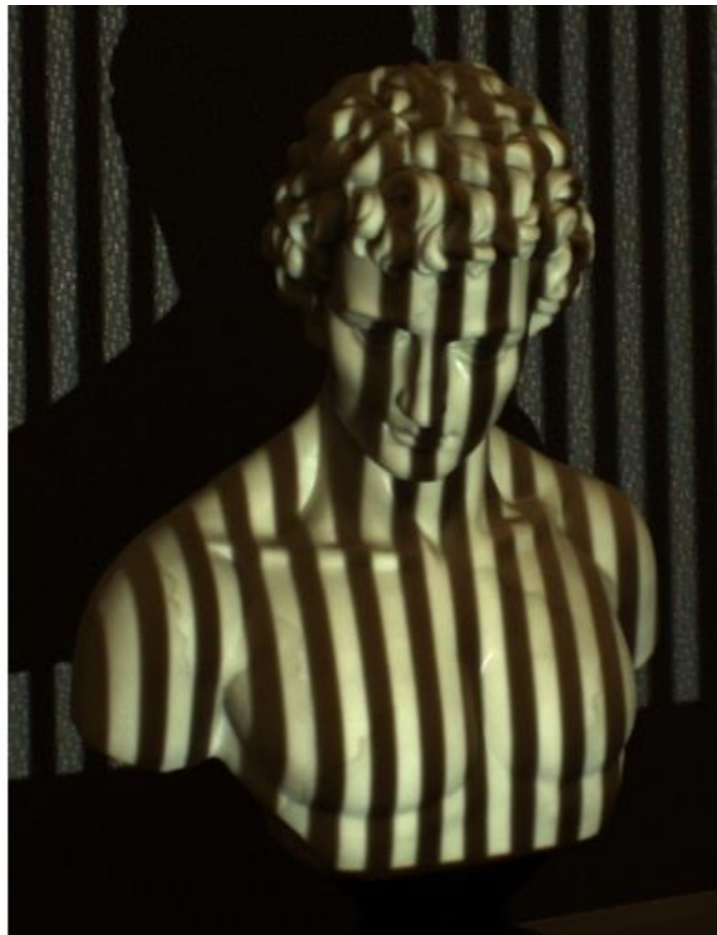

Structured light scanner

- Simple design, no sweeping/translating devices needed
- Fast acquisition (a single image for each multi-stripe pattern)
- Ambiguity problem with a single pattern to identify which stripe light each pixel

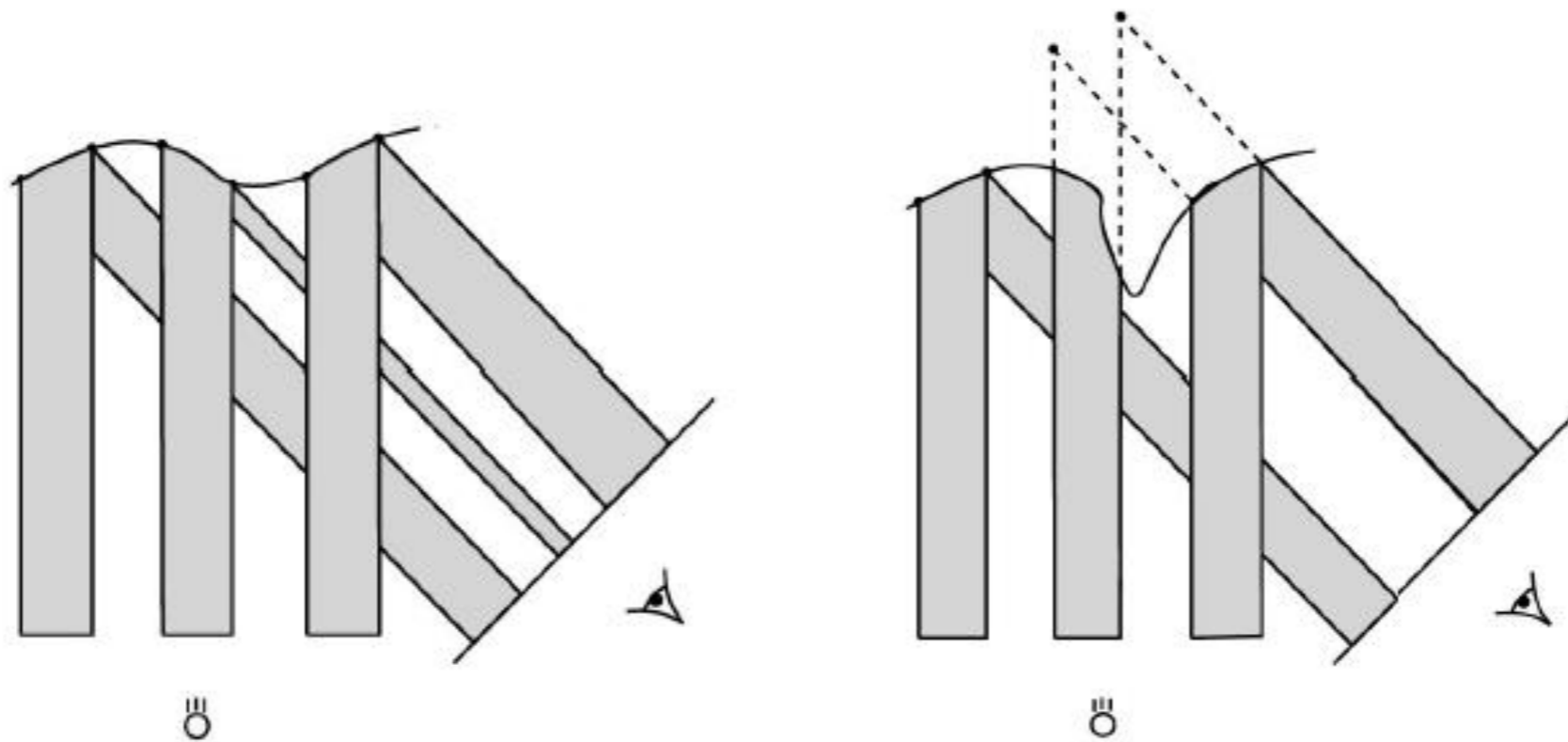

Structured light scanner

- How to solve the ambiguity?
- Many coding strategies that can be used to recover which camera pixel views the light from a given plane
 - Temporal coding – Multiple patterns in the time, matching using the time sequence of the image intensity, slower but more accurate
 - Spatial coding – A single pattern, the local neighborhood is used to perform the matching, more suitable for dynamic scene
 - Direct coding – A different code for every pixel

Temporal Coding

Binary Code

- Two illumination levels: 0 and 1
- Every point is identified by the sequence of intensities that it receives
- The resolution is limited to half the size of the finest pattern

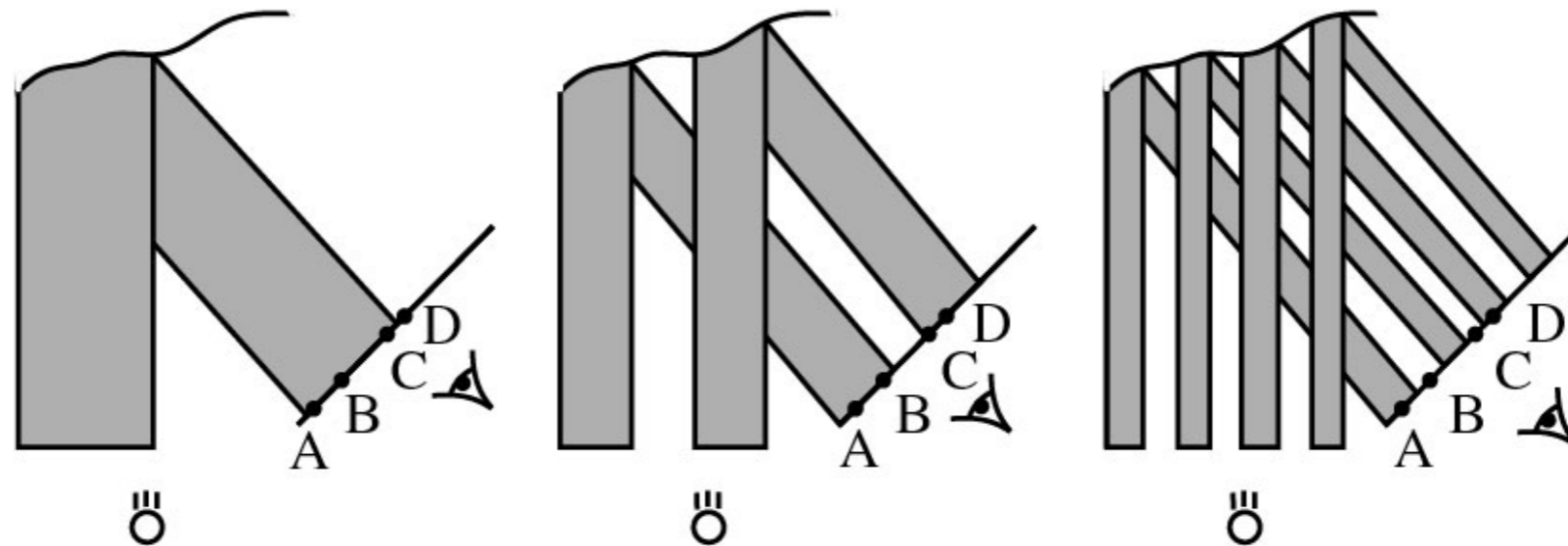
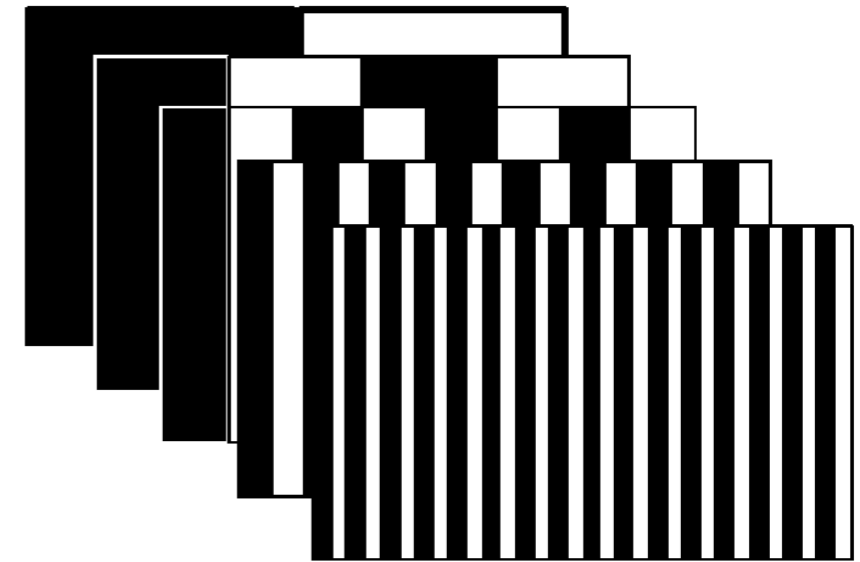

Binary codes:

A = 1 1 1 C = 1 0 0
B = 1 1 0 D = 0 1 1

Temporal Coding

- Binary Code

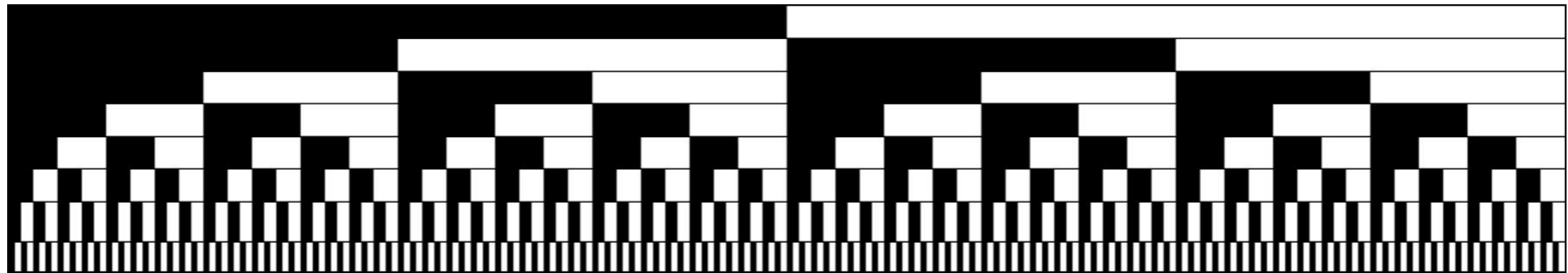

- Gray Code – Neighboring columns differ by one bit then more robust to decoding error

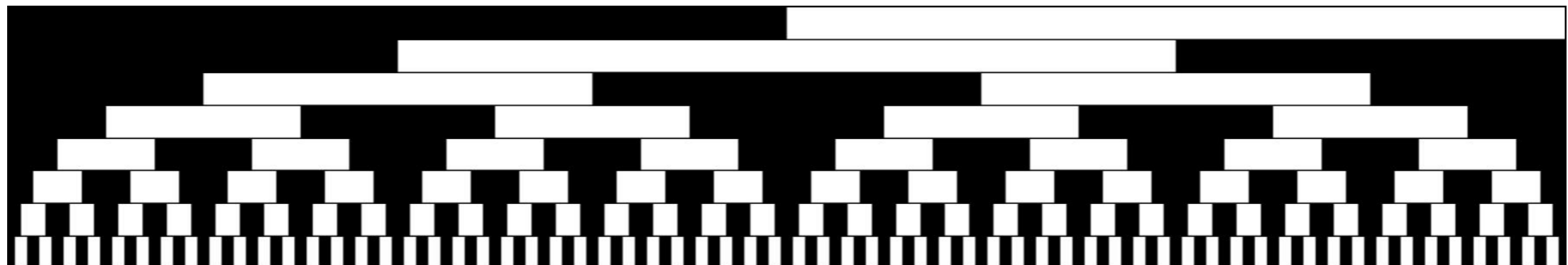

Temporal Coding

- Location of the stripes
 - Simple thresholding - Per-pixel threshold as average of two images acquired with all-white and all-black patterns
 - Pixel accuracy

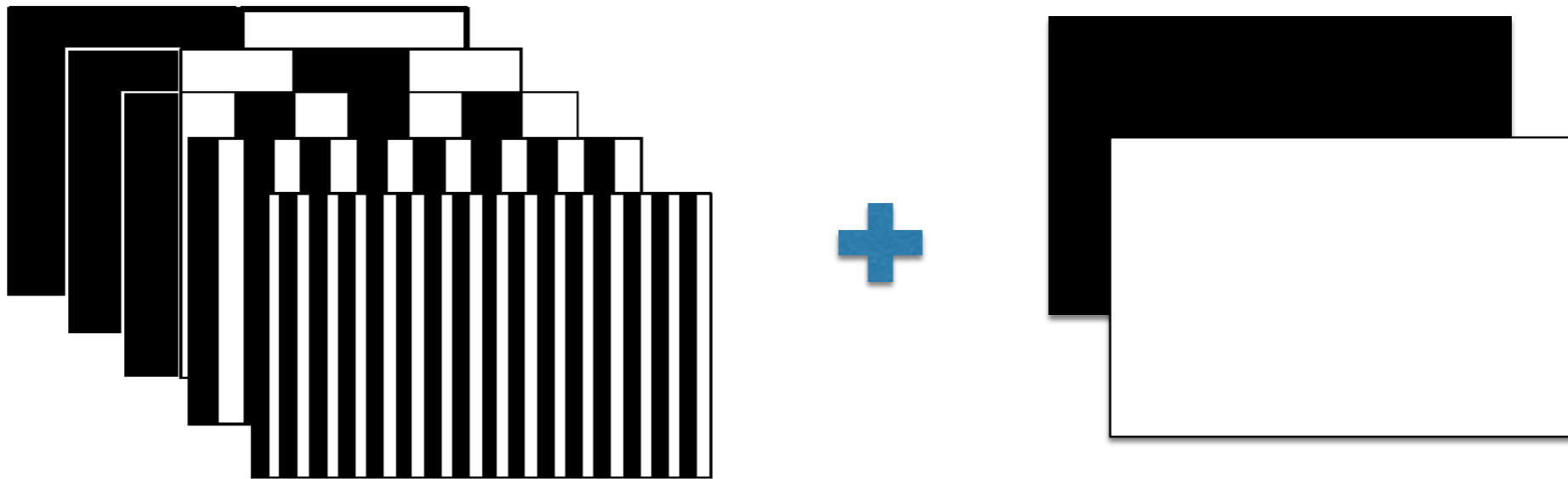

Temporal Coding

- Location of the stripes
 - Projection of Gray code and reserve Gray code and intersection of the relative intensity profile- Sub-pixel accuracy

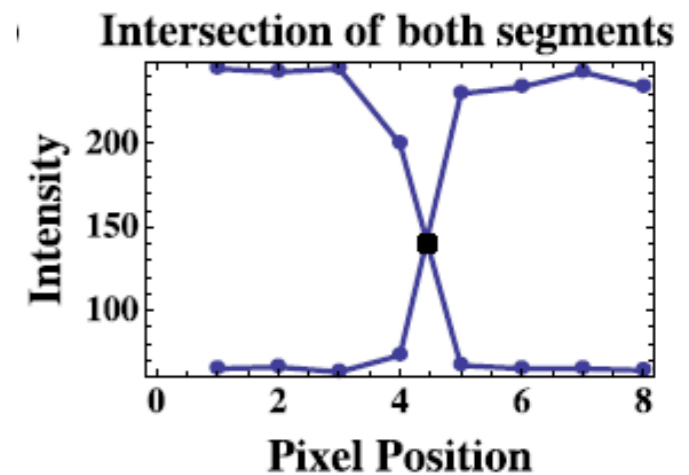
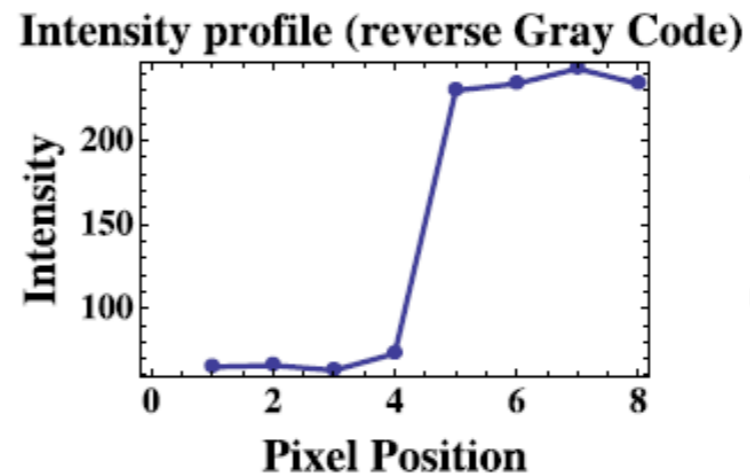
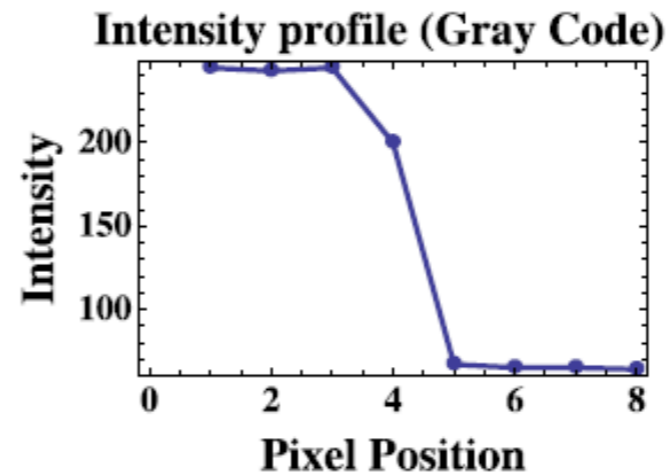
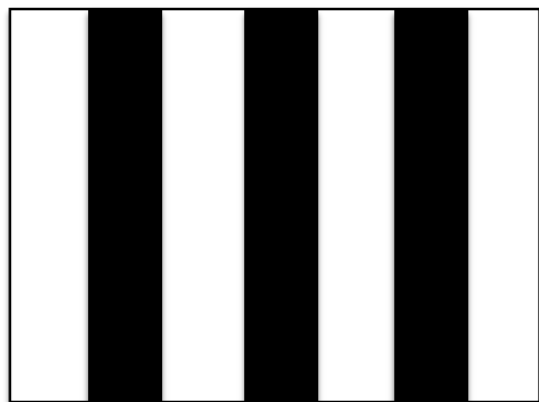
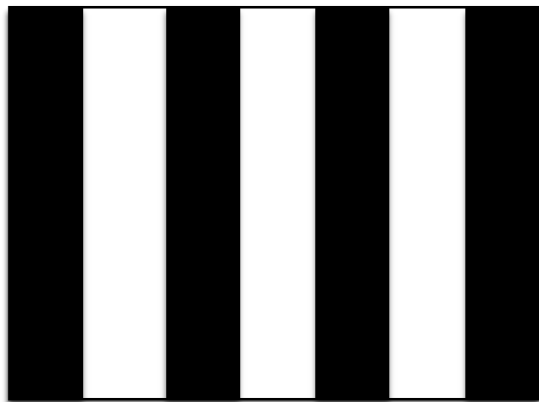

[Drouin et al., 2012]

Temporal Coding

- N-ary code – Reduce the number of patterns by increasing the number of intensity levels used to encode the stripes.

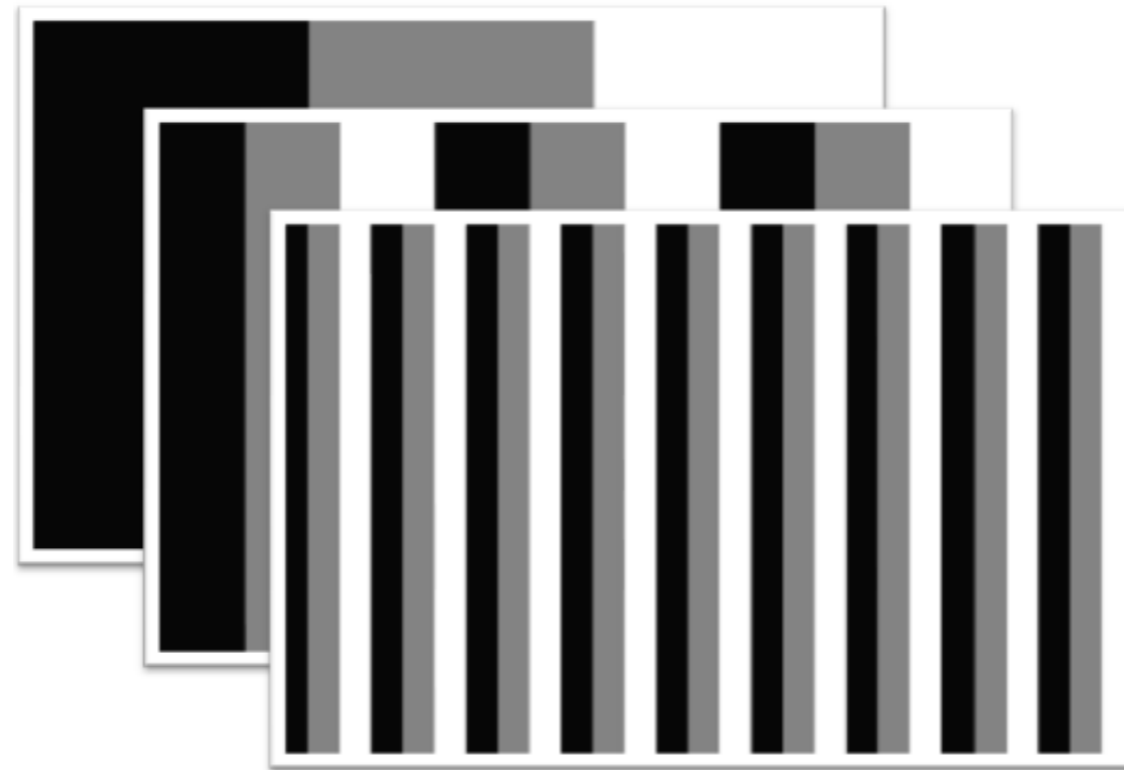

Temporal Coding

- Phase Shift
 - Projection of a set of sinusoidal pattern shifted of a constant angle
 - High resolution than Gray code
 - Ambiguity problem due the periodic nature of the pattern

$$I(x) = A + B \cos\left(\frac{2\pi}{\omega}(x \bmod \omega) - \theta\right)$$

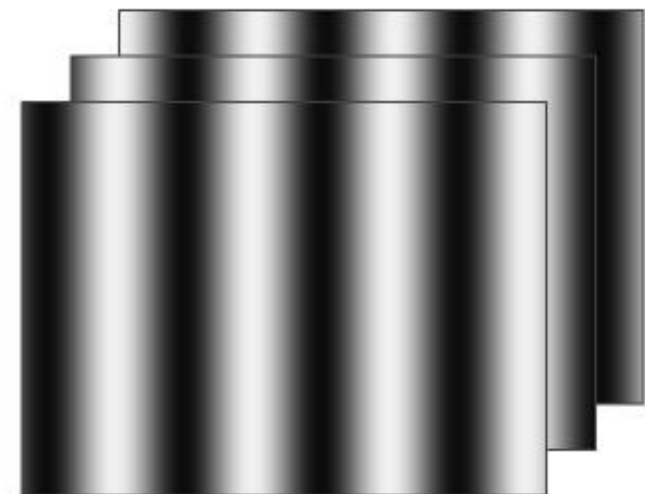

Temporal Coding

- Gray Code + Phase Shift [Gühring , 2000]
 - Coarse correspondence projector-camera with Gray code to remove ambiguity
 - Refinement with phase shift
 - Problem with non-constant albedo surface

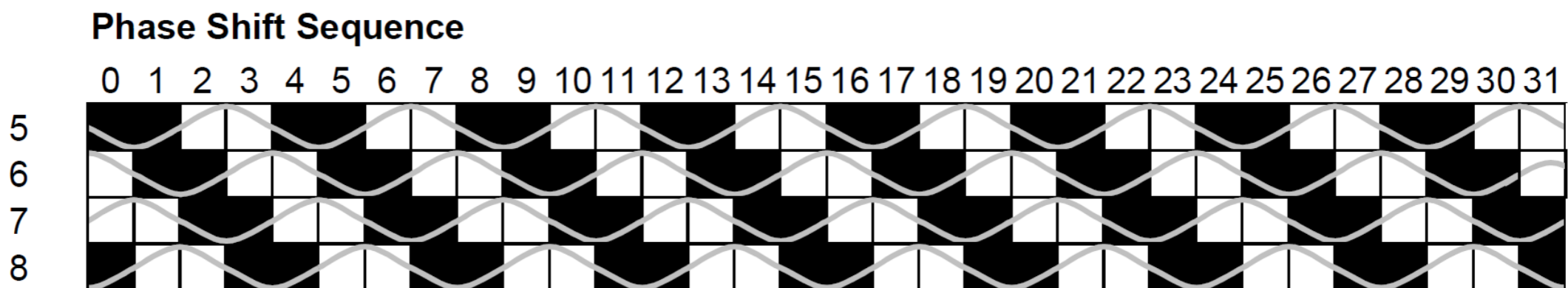
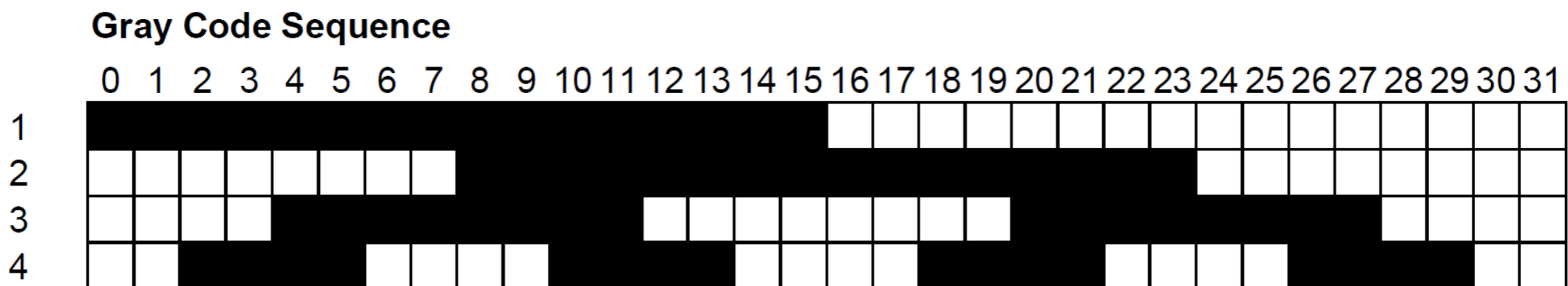

Temporal Coding

- Gray Code + Line Shift [Gühring , 2000]
- Substitution the sinusoidal pattern with a pattern of equally spaced vertical line

Gray Code Sequence

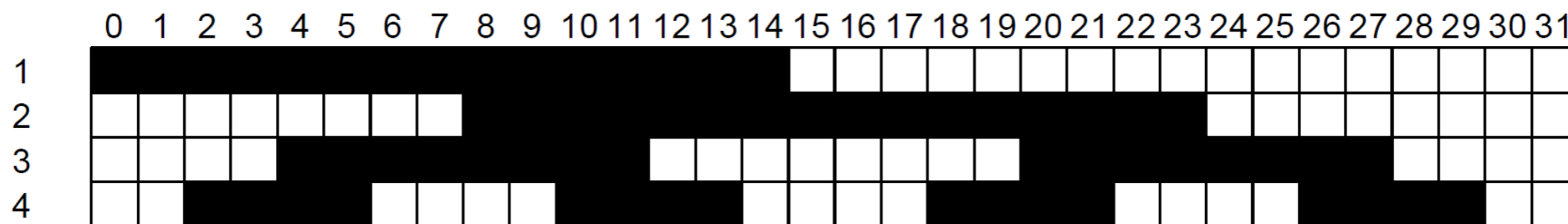

Line Shift Sequence (Pattern Length: 6 Lines)



Spatial Coding

- The label of a point of the pattern is obtained from a neighborhood around it.
- The decoding stage more difficult since the spatial neighborhood cannot always be recovered (fringe not visible from the camera due to occlusion)

[Zhang et al.,
3DPVT 2002]

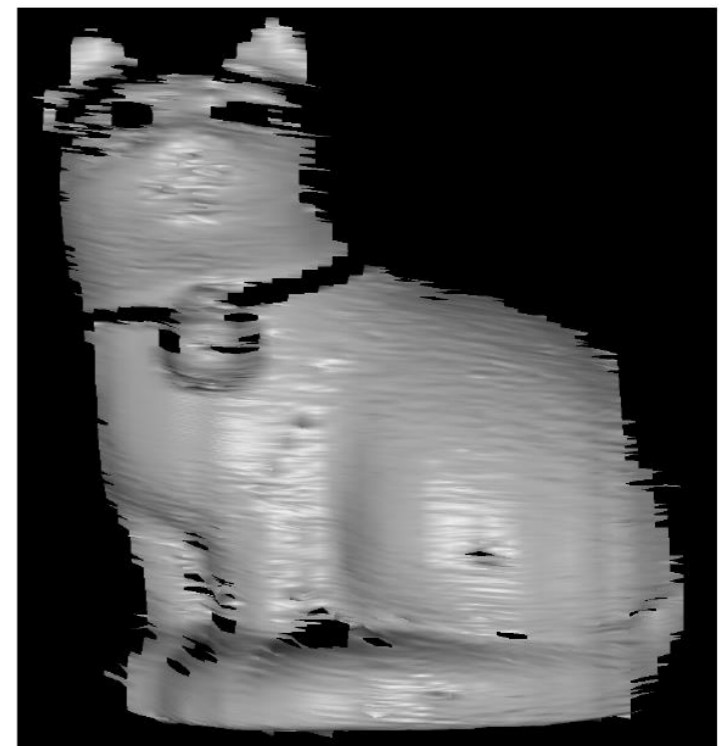

Direct Coding

- Every encoded pixel is identified by its own intensity/color
- The spectrum of intensities/colors used is very large
- Sensible to the reflective properties of the object, low accuracy, need accurate calibration



RAINBOW PATTERN

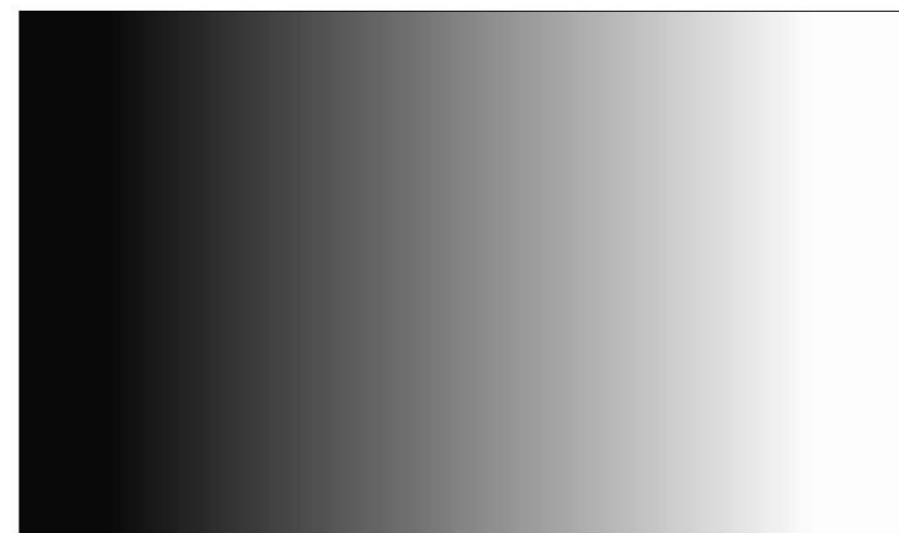

GREY LEVEL SCALE
PATTERN

Time of Flight

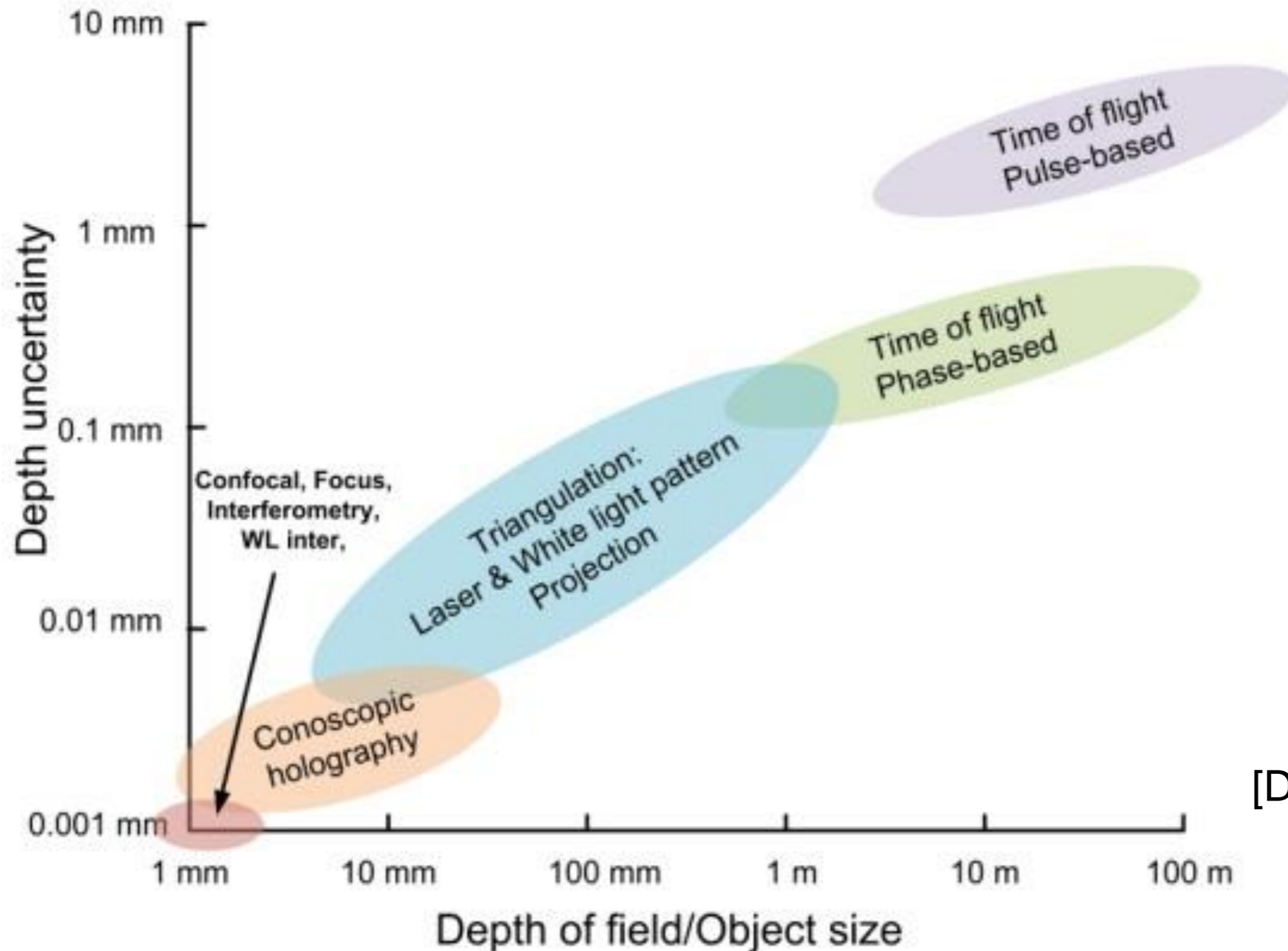

[Drouin et al., 2012]

Pulse-based Time of Flight Scanning

- Measure the time a light impulse needs to travel from emitter to target
 - Source: emits a light pulse and starts a nanosecond watch (1m = 6.67ns)
 - Sensor: detects the reflected light, stops the watch (roundtrip time)

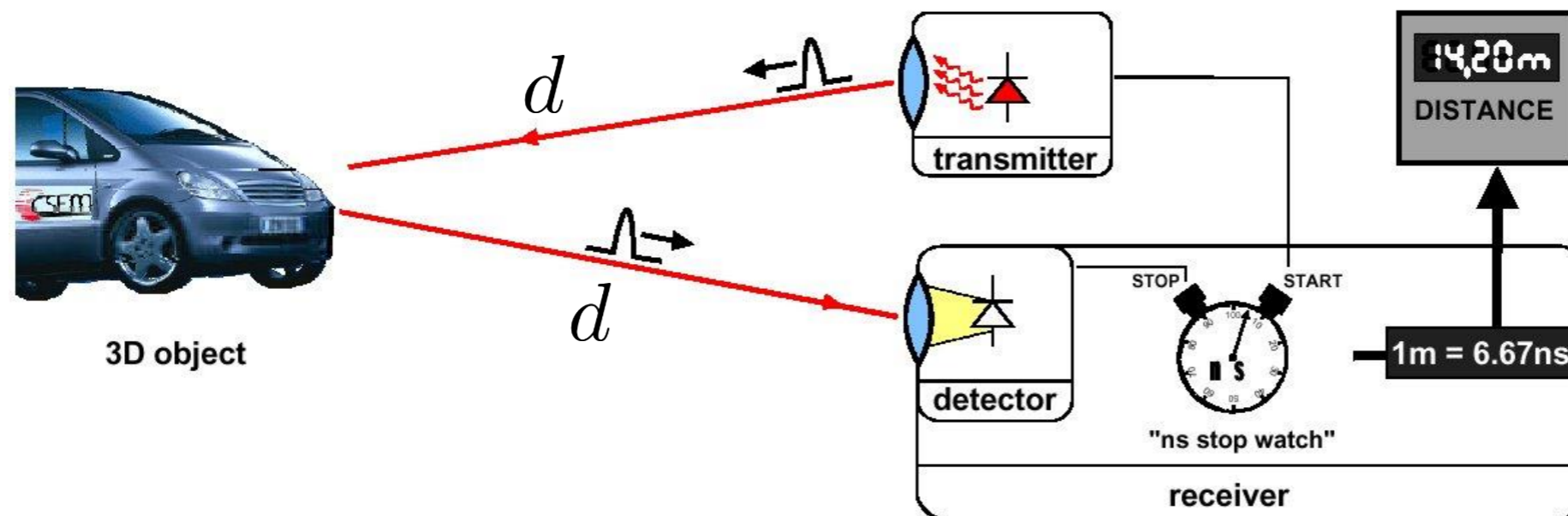

$$d = c \frac{\Delta t}{2}$$

Pulse-based Time of Flight Scanning

- Scanning
 - Single spot measure
 - Range map obtained by rotating mirrors or motorized 2 DOF head
- Advantages
 - No triangulation, source and detector on the same axis (no shadow effect)

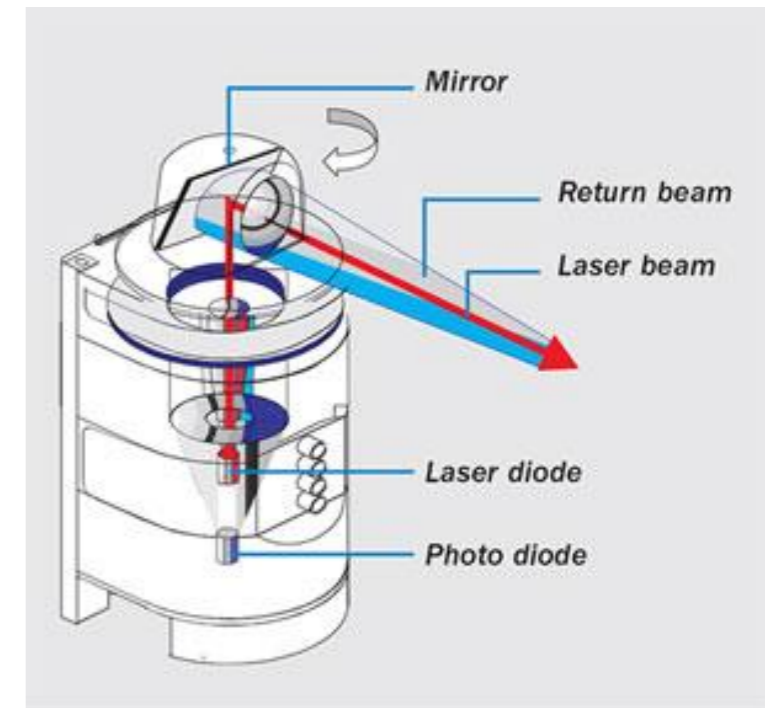

Phase-based Time of Flight Scanning

- A laser beam with sinusoidal modulated optical power is sent to a target. The phase of the reflected light is compared with that of the sent light

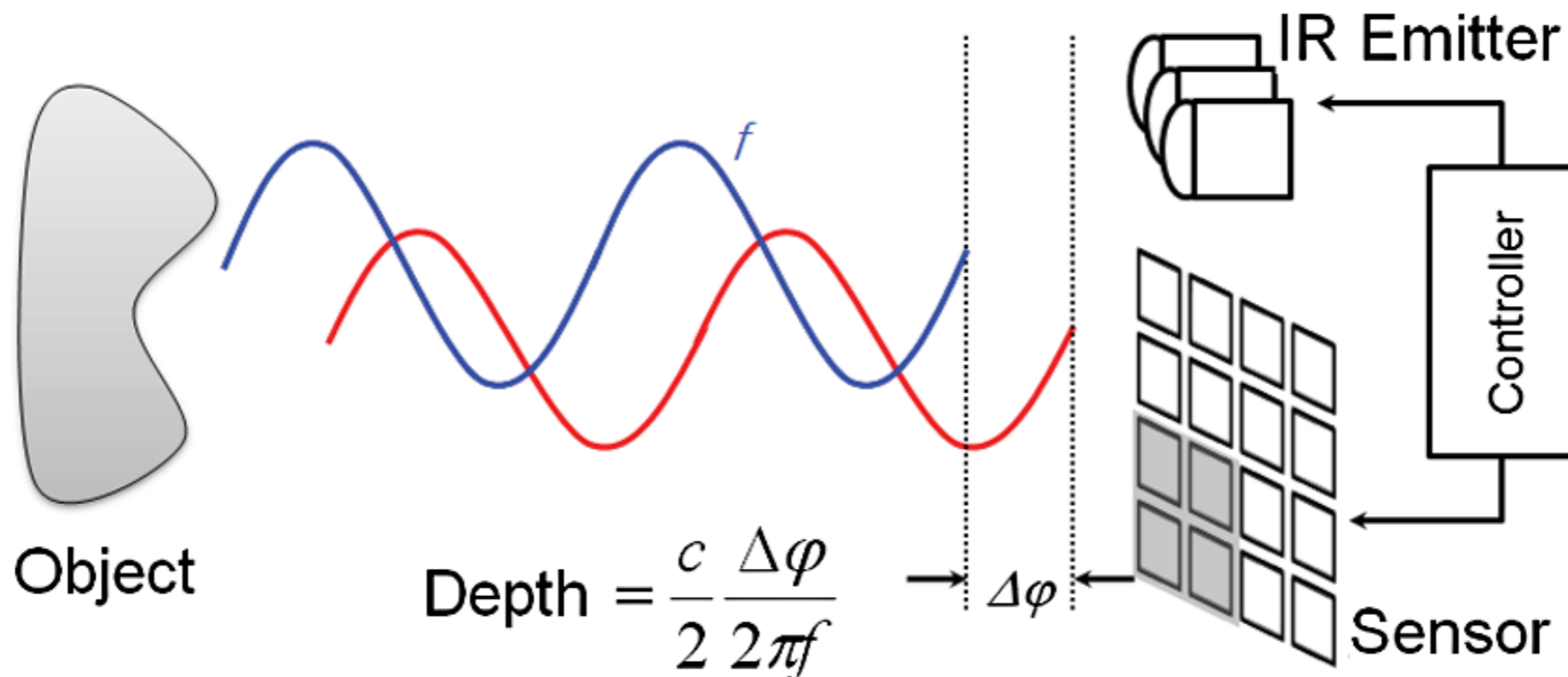

Phase-based Time of Flight Scanning

[Foix et al., 2011]

- Ambiguity of the phase shift. When $\Delta\phi = 2\pi$, the unambiguous distance measurement is limited to $c/(2f)$ (e.g. with frequency 16.66 MHz a maximum distance of 9m)

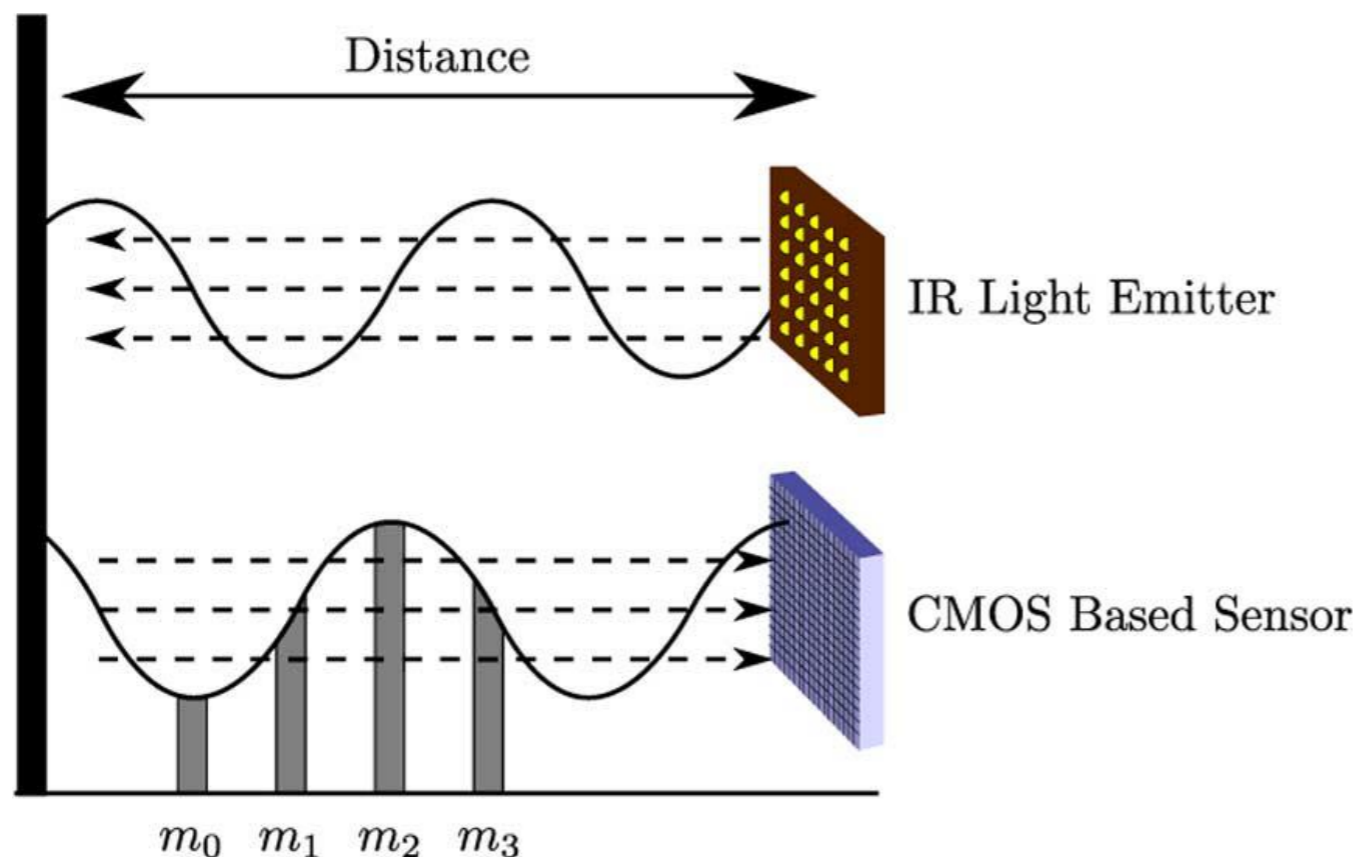

$$\Delta\phi = \arctan \frac{m_3 - m_1}{m_0 - m_2}$$

Time of Flight Scanning

In principle is an easy approach, but:

- maximum distance range limited by the amount of light received by the detector (power of the emitter, environment illumination)
- accuracy depends on : optical noise, thermal noise, ratio between reflected signal intensity and ambient light intensity
- Accurate and fast systems are still expensive (70K-100K Euro)
- Cost depends on mechanical components (high-quality rotation unit, to span the spherical space around the scanner)

References

- de Groot, Peter J. "31 Interference Microscopy for Surface Structure Analysis." (2015).
- Gava, Didier, and Francoise J. Preteux. "3D conoscopic vision." *Optical Science, Engineering and Instrumentation'97*. International Society for Optics and Photonics, 1997.
- Blais, François. "Review of 20 years of range sensor development." *Journal of Electronic Imaging* 13.1 (2004): 231-243.
- Salvi, Joaquim, Jordi Pages, and Joan Batlle. "Pattern codification strategies in structured light systems." *Pattern recognition* 37.4 (2004): 827-849.
- Lanman, Douglas, and Gabriel Taubin. "Build your own 3D scanner: 3D photography for beginners." *ACM SIGGRAPH 2009 Courses*. ACM, 2009.
- Curless, Brian, and Marc Levoy. "Better optical triangulation through spacetime analysis." *Computer Vision, 1995. Proceedings., Fifth International Conference on*. IEEE, 1995.
- Drouin, Marc-Antoine, and Jean-Angelo Beraldin. "Active 3D Imaging Systems." *3D Imaging, Analysis and Applications*. Springer London, 2012. 95-138.
- Foix, Sergi, Guillem Alenya, and Carme Torras. "Lock-in time-of-flight (ToF) cameras: A survey." *IEEE Sensors Journal* 11.9 (2011): 1917-1926.
- Gühring, Jens. "Dense 3D surface acquisition by structured light using off-the-shelf components." *Photonics West 2001-Electronic Imaging*. International, 2000.
- Zhang, Li, Brian Curless, and Steven M. Seitz. "Rapid shape acquisition using color structured light and multi-pass dynamic programming." *3D Data Processing Visualization and Transmission*, 2002.